

# DENON

Hi-Fi AM-FM Stereo Tuner

## SERVICE MANUAL

# MODEL TU-1500 MODEL TU-1500RD

## AM-FM STEREO TUNER

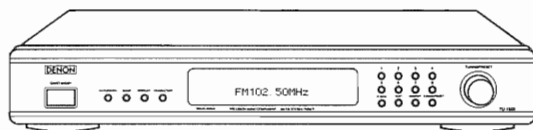

TU-1500

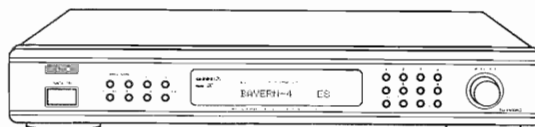

TU-1500RD



### — TABLE OF CONTENTS —

OPERATING INSTRUCTIONS .....	2-11
BLOCK DIAGRAM .....	13
DISASSEMBLY .....	14
METHOD OF ADJUSTMENTS .....	15
SEMICONDUCTORS .....	16-21
NOTE FOR PARTS LIST .....	22
PARTS LIST OF P.W.BOARD .....	22-28
PRINTED WIRING BOARD .....	29
EXPLODED VIEW .....	30
PARTS LIST OF EXPLODED VIEW .....	31
PARTS LIST OF PACKING & ACCESSORIES .....	31
SCHEMATIC DIAGRAM .....	32,33

● Some illustrations using in this service manual are slightly different from the actual set.

# NIPPON COLUMBIA CO., LTD.

• SAFETY PRECAUTIONS



**CAUTION**

**RISK OF ELECTRIC SHOCK**

**DO NOT OPEN**



**CAUTION: TO REDUCE THE RISK OF ELECTRIC SHOCK, DO NOT REMOVE COVER (OR BACK). NO USER SERVICEABLE PARTS INSIDE. REFER SERVICING TO QUALIFIED SERVICE PERSONNEL.**



The lightning flash with arrowhead symbol, within an equilateral triangle, is intended to alert the user to the presence of uninsulated "dangerous voltage" within the product's enclosure that may be of sufficient magnitude to constitute a risk of electric shock to persons.



The exclamation point within an equilateral triangle is intended to alert the user to the presence of important operating and maintenance (servicing) instructions in the literature accompanying the appliance.

**WARNING: TO REDUCE THE RISK OF FIRE OR ELECTRIC SHOCK, DO NOT EXPOSE THIS APPLIANCE TO RAIN OR MOISTURE.**

● DECLARATION OF CONFORMITY

We declare under our sole responsibility that this product, to which this declaration relates, is in conformity with the following standards:  
EN55013, EN55020, EN60555-2 and EN60555-3.

● ÜBEREINSTIMMUNGSERKLÄRUNG

Wir erklären unter unserer Verantwortung, daß dieses Produkt, auf das sich diese Erklärung bezieht, den folgenden Standards entspricht:  
EN55013, EN55020, EN60555-2 und EN60555-3.

● DECLARATION DE CONFORMITE

Nous déclarons sous notre seule responsabilité que l'appareil, auquel se réfère cette déclaration, est conforme aux standards suivants:  
EN55013, EN55020, EN60555-2 et EN60555-3.

● DICHIARAZIONE DI CONFORMITÀ

Dichiariamo con piena responsabilità che questo prodotto, al quale la nostra dichiarazione si riferisce, è conforme alle seguenti normative:  
EN55013, EN55020, EN60555-2 e EN60555-3.  
QUESTO PRODOTTO E' CONFORME  
AL D.M. 28/08/95 N. 548

● DECLARACIÓN DE CONFORMIDAD

Declaramos bajo nuestra exclusiva responsabilidad que este producto al que hace referencia esta declaración, está conforme con los siguientes estándares:  
EN55013, EN55020, EN60555-2 y EN60555-3.

● EENVORMIGHEIDSVRKLARING

Wij verklaren uitsluitend op onze verantwoordelijkheid dat dit product, waarop deze verklaring betrekking heeft, in overeenstemming is met de volgende normen:  
EN55013, EN55020, EN60555-2 en EN60555-3.

● ÖVERENSSTÄMMELSEINTYG

Härmed intygas helt på eget ansvar att denna produkt, vilken detta intyg avser, uppfyller följande standarder:  
EN55013, EN55020, EN60555-2 och EN60555-3.

● DECLARAÇÃO DE CONFORMIDADE

Declaramos sob nossa exclusiva responsabilidade que este produto, ao qual esta declaração corresponde, está em conformidade com as seguintes normas:  
EN55013, EN55020, EN60555-2 e EN60555-3.

FRONT PANEL  
FRONTPLATTE  
PANNEAU AVANT  
PANNELLO FRONTALE

TABLERO FRONTAL  
VOORPANEEL  
FRONT PANELEN  
PAINEL FRONTAL

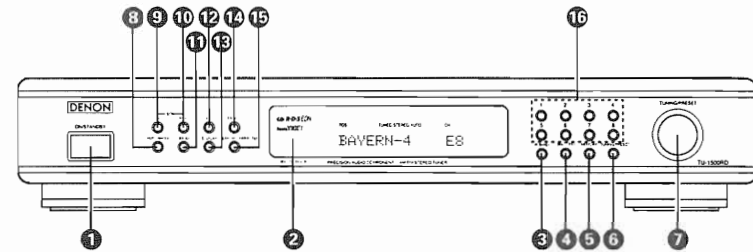

REAR PANEL  
RÜCKWAND  
PANNEAU ARRIERE  
IL PANNELLO POSTERIORE

PANEL TRASERO  
ACHTERPANEEL  
BAKSIDAN  
PAINEL TRAZEIRO

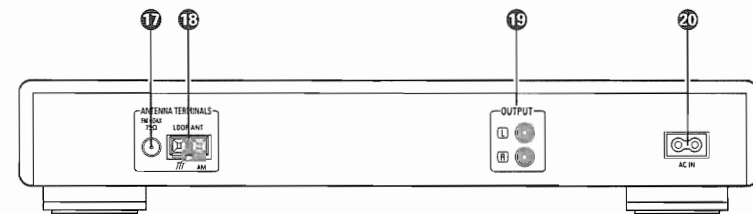

REMOTE CONTROL UNIT  
FERNBEDIENUNG



UNITE DE TELECOMMANDE  
TELECOMANDO

UNIDAD DE CONTROL REMOTO  
AFSTANSBEDIENING

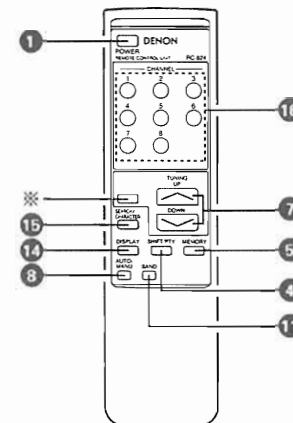
FJÄRRKONTROLL  
UNIDADE DE CONTROLE REMOTO



**NOTE ON USE/HINWEISE ZUM GEBRAUCH/OBSERVATIONS RELATIVES A L'UTILISATION  
NOTE SULL'USO/NOTAS SOBRE EL USO/ALVORENS TE GEBRUIKEN/OBSERVERA  
OBSERVAÇÕES QUANTO AO USO**

 <ul style="list-style-type: none"> <li>• Avoid high temperatures Allow for sufficient heat dispersion when installed on a rack.</li> <li>• Vermeiden Sie hohe Temperaturen Beachten Sie, daß eine ausreichende Luftzirkulation gewährleistet wird, wenn das Gerät auf ein Regal gestellt wird.</li> <li>• Eviter des températures élevées Tenir compte d'une dispersion de chaleur suffisante lors de l'installation sur une étagère.</li> <li>• Evitate di esporre l'unità a temperature alte. Assicuratevi che ci sia un'adeguata dispersione del calore quando installate l'unità in un mobile per componenti audio.</li> <li>• Evite altas temperaturas Permite la suficiente dispersión del calor cuando está instalado en la consola.</li> <li>• Vermijd hoge temperaturen Zorg voor een degelek hitteafvoer indien het apparaat op een rek wordt geplaatst.</li> <li>• Undvik høge temperaturer Se till att det finns möjlighet till god värmeavledning vid montering i ett rack.</li> <li>• Evite temperaturas altas Cuide-se suficiente dispersão de calor quando o equipamento for instalado numa prateleira.</li> </ul>	 <ul style="list-style-type: none"> <li>• Keep the set free from moisture, water, and dust.</li> <li>• Halten Sie das Gerät von Feuchtigkeit, Wasser und Staub fern.</li> <li>• Protéger l'appareil contre l'humidité, l'eau et la poussière.</li> <li>• Tenete l'unità lontana dall'umidità, dall'acqua e dalla polvere.</li> <li>• Mantenga el equipo libre de humedad, agua y polvo.</li> <li>• Laat geen vochtigheid, water of stof in het apparaat binnendringen.</li> <li>• Utsatt inte apparaten för fukt, vatten och damm.</li> <li>• Mantenha o aparelho livre de qualquer umidade de água ou poeira.</li> </ul>	 <ul style="list-style-type: none"> <li>• Do not let foreign objects in the set.</li> <li>• Keine Fremder Gegenstände in das Gerät kommen lassen.</li> <li>• Ne pas laisser des objets étrangers dans l'appareil.</li> <li>• È importante che nessun oggetto è inserito all'interno dell'unità.</li> <li>• No debe obetios extraños dentro del equipo.</li> <li>• Laat geen vreemde voorwerpen in dit apparaat vallen.</li> <li>• Se till att frammande föremål inte tränger in i apparaten.</li> <li>• Não deixe objetos estranhos no aparelho.</li> </ul>
 <ul style="list-style-type: none"> <li>• Handle the power cord carefully Hold the plug when unplugging the cord.</li> <li>• Gehen Sie vorsichtig mit dem Netzkabel um. Halten Sie das Kabel am Stecker, wenn Sie den Stecker herausziehen.</li> <li>• Manipuler le cordon d'alimentation avec précaution. Tenir la prise lors du débranchement du cordon.</li> <li>• Maneggiare il filo di alimentazione con cura. Agitare per la spina quando scollegate il cavo dalla presa.</li> <li>• Maneje el cordón de energía con cuidado. Sostenga el enchufe cuando desconecte el cordón de energía.</li> <li>• Hanteer het netsnoer voorzichtig. Houd het snoer bij de stecker vast wanneer deze moet worden aan- of losgekoppeld.</li> <li>• Hantera nätkabeln varsamt. Håll i kabeln när den kopplas från el-uttaget.</li> <li>• Manuseie com cuidado o fio condutor de energia. Segure a tomada ao desconectar o fio.</li> </ul>	 <ul style="list-style-type: none"> <li>• Unplug the power cord when not using the set for some periods of time.</li> <li>• Wenn das Gerät eine längere Zeit nicht verwendet werden soll, trennen Sie das Netzkabel vom Netzstecker.</li> <li>• Débrancher le cordon d'alimentation lorsque l'appareil n'est pas utilisé pendant de longues périodes.</li> <li>• Disinnestare il filo di alimentazione quando invece l'installazione di non usare il filo di alimentazione per un lungo periodo di tempo.</li> <li>• Desconecte el cordón de energía cuando no utilice el equipo por mucho tiempo.</li> <li>• Naem altijd het netsnoer uit het stopcontact wanneer het apparaat gedurende een lange periode niet wordt gebruikt.</li> <li>• Koppla ur nätkabeln om apparaten inte kommer att användas i lång tid.</li> <li>• Desligue o fio condutor de força quando o aparelho não tiver que ser usado por um longo período.</li> </ul>	 <ul style="list-style-type: none"> <li>• Do not let insecticides, benzene, and thinner come in contact with the set.</li> <li>• Lassen Sie das Gerät nicht mit Insektiziden, Benzin oder Verdünnungsmitteln in Berührung kommen.</li> <li>• Ne pas mettre en contact des insecticides, du benzène et un diluant avec l'appareil.</li> <li>• Assicurarsi che l'unità non venga in contatto con insetticidi, benzolo o solventi.</li> <li>• No permita el contacto de insecticidas, gasolina y diluyentes con el equipo.</li> <li>• Laat geen insectenverdelgende middelen, benzine of verdunningsmiddelen met dit apparaat in contact komen.</li> <li>• Se till att inte insektsmedel på språkbruk, bensin och thinner kommer i kontakt med apparatens hölje.</li> <li>• Não permita que inseticidas, benzina e diluante entrem em contacto com o aparelho.</li> </ul>
 <ul style="list-style-type: none"> <li>• Handle the power cord carefully Hold the plug when unplugging the cord.</li> <li>• Gehen Sie vorsichtig mit dem Netzkabel um. Halten Sie das Kabel am Stecker, wenn Sie den Stecker herausziehen.</li> <li>• Manipuler le cordon d'alimentation avec précaution. Tenir la prise lors du débranchement du cordon.</li> <li>• Maneggiare il filo di alimentazione con cura. Agitare per la spina quando scollegate il cavo dalla presa.</li> <li>• Maneje el cordón de energía con cuidado. Sostenga el enchufe cuando desconecte el cordón de energía.</li> <li>• Hanteer het netsnoer voorzichtig. Houd het snoer bij de stecker vast wanneer deze moet worden aan- of losgekoppeld.</li> <li>• Hantera nätkabeln varsamt. Håll i kabeln när den kopplas från el-uttaget.</li> <li>• Manuseie com cuidado o fio condutor de energia. Segure a tomada ao desconectar o fio.</li> </ul>	 <p>* (For sets with ventilation holes)</p> <ul style="list-style-type: none"> <li>• Do not obstruct the ventilation holes</li> <li>• Die Belüftungslöcher dürfen nicht verdeckt werden.</li> <li>• Ne pas obstruer les trous d'aération.</li> <li>• Non coprire i fori di ventilazione.</li> <li>• No obstruya los orificios de ventilación.</li> <li>• De ventilatieopeningen mogen niet worden blokkeerd.</li> <li>• Tapp inte till ventilationsöppningarna.</li> <li>• Não obstrua os orificios de ventilação.</li> </ul>	 <ul style="list-style-type: none"> <li>• Never disassemble or modify the set in any way.</li> <li>• Versuchen Sie niemals das Gerät auseinander zu nehmen oder auf jegliche Art zu verändern.</li> <li>• Ne jamais démonter ou modifier l'appareil d'une manière ou d'une autre.</li> <li>• Non smontate mai, né modificate l'unità in nessun modo.</li> <li>• Nunca desarme o modifique el equipo de ninguna manera.</li> <li>• Noot dit apparaat demonteren of op andere wijze modificeren.</li> <li>• Ta inte isär apparaten och försök inte bygga om den.</li> <li>• Nunca desmonte ou modifique o aparelho de alguma forma.</li> </ul>

**ENGLISH**

Please check to make sure the following items are included with the main unit in the carton:

(1) Operating Instructions	1
(2) AC Cord	1
(3) Connecting Cord	1
(4) AM Loop Antenna	1
(5) FM Indoor Antenna	1
(6) Remote Control RC-824	1
(7) Batteries R6 (AAA)	2
(8) Service Station List	1

**DEUTSCH**

Bitte überprüfen Sie, ob die folgenden Teile vollständig in der Verpackung enthalten sind:

(1) Bedienungsanleitung	1
(2) Netzkabel	1
(3) Anschlusskabel	1
(4) MW-Rahmenantenne	1
(5) UKW-Zimmerantenne	1
(6) Fernbedienung RC-824	1
(7) Trockenzelle-Batterie R6 (AAA)	2
(8) Service-Sender-Liste	1

**FRAÇAIS**

Veuillez contrôler que les articles suivants sont bien joints à l'appareil principal dans le carton:

(1) Mode d'emploi	1
(2) Cordon Secteur	1
(3) Cordon de connexion	1
(4) Antenne Cadre AM	1
(5) Antenne FM Interieure	1
(6) Télécommande RC-824	1
(7) Piles de format R6 (AAA)	2
(8) Liste des stations techniques agréées	1

**ITALIANO**

Controllare che le parti seguenti si trovino imballate con l'apparecchio nella scatola di spedizione.

(1) Istruzioni per l'uso	1
(2) Cavo CA	1
(3) Cavo di connessione	1
(4) Antenna AM a Quadro	1
(5) Antenna FM Interna	1
(6) Telecomando RC-824	1
(7) Batterie secca R6 (AAA)	2
(8) Lista dei centri di assistenza tecnica	1

**Table of characters**

The characters are input in the order shown below. Use the TUNING/PRESET control to select the desired characters.

**Zeichentabelle**

Die Zeichen werden in der unten angegebenen Reihenfolge eingegeben. Wählen Sie die gewünschten Zeichen mit dem TUNING/PRESET-Knopf.

**Table des caractères**

Les caractères sont introduits dans l'ordre indiqué ci-dessous. Utilisez la commande TUNING/PRESET pour sélectionner les caractères désirés.

**Tabella dei caratteri**

I caratteri vengono immessi nell'ordine visualizzato qui sotto. Usare il controllo TUNING/PRESET per selezionare i caratteri desiderati.

A,B,C,D,E,F,G,H,I,J,K,L,M,N,O,P,Q,R,S,T,U,V,W,X,  
Y,Z,0,1,2,3,4,5,6,7,8,9,C,/,^,\_,!,",#,%&,' ,  
( ),\*,+,=,.,/,>,<,>,?,(space)

**ESPAÑOL**

Por favor verifique asegurándose de que los siguientes artículos son empacados en la caja pero separados de la unidad principal.

(1) Instrucciones de operación	1
(2) Cable de alimentación	1
(3) Cordón de conexión	1
(4) Antena AM de Cuadro	1
(5) Antena FM interior	1
(6) Unidad de control remoto RC-824	1
(7) Pilas secas R6 (AAA)	2
(8) Lista de estaciones de servicio	1

**NEREDLANDS**

Kontroleer of de volgende accessoires bij het hoofdtoestel in de doos zijn verpakt:

(1) Gebruiksaanwijzing	1
(2) Netkabel	1
(3) Aansluitingskabel	1
(4) AM-Ramenantenne	1
(5) FM-Binnenantenne	1
(6) Afstandsbediening RC-824	1
(7) R6 (AAA) droge cellen	2
(8) Lijst met service-adressen	1

**SVENSKA**

Kontrollera att följande, förutom huvudapparaten, finns med i kartongen.

(1) Bruksanvisning	1
(2) Nettkabel	1
(3) Anslutningskabel	1
(4) AM-Ramantenn	1
(5) FM-Inomhusantenn	1
(6) Fjärrkontroll RC-824	1
(7) R6 (AAA) torrbatterier	2
(8) Lista över service-ställen	1

**PORTUGUÊS**

Certifique-se de que as seguintes peças estão incluídas na embalagem fora da unidade principal:

(1) Instruções de operação	1
(2) Cabo de Alimentação	1
(3) Cabo de ligação	1
(4) Antena de quadro AM	1
(5) Antena de interior FM	1
(6) Controlador remoto RC-824	1
(7) Pilhas R6 (AAA)	2
(8) Lista de Estações de Serviço	1

**Tabla de caracteres**

Los caracteres se ingresan en el orden que se indica abajo. Utilice el control TUNING/PRESET para seleccionar los caracteres deseados.

**Lettertabel**

De letters worden in de hieronder getoonde volgorde ingevoerd. Gebruik de TUNING/PRESET om de gewenste karakters te kiezen.

**Teckentabell**

Tecken kan matas in enligt ordningen nedan. Använd TUNING/PRESET-kontrollen för att välja tecken.

**Tabla de caracteres**

Os caracteres são entrados pela ordem que se mostra abaixo. Utilizar o controle TUNING/PRESET para seleccionar os caracteres desejados.

**CONNECTIONS  
ANSCHLÜSSE  
CONNEXIONS  
COLLEGAMENTI**

DIRECTION OF BROADCASTING STATION  
RICHTUNG DES SENDERS  
DIRECTION DE LA STATION EMETTEUR  
DIREZIONE DELLA STAZIONE TRASMETTENTE

- (FOR WEAK SIGNAL RECEPTION)  
When an outdoor antenna is used, do not detach the lead wires of the loop antenna from the terminals.
- (BEI SCHWACH EINFALLENDEN SIGNALS)  
Wenn eine Außenantenne verwendet wird, Drähte der Rahmenantenne nicht von den Klemmen abtrennen.
- (POUR RECEPTION D'ONDE FAIBLE)  
À l'emploi d'une antenne extérieure, Ne pas débrancher les conducteurs de l'antenne cadre au niveau des bornes.
- (PER UNA RICEZIONE DEI SEGNALI DEBOLI)  
Quando usate un'antenna esterna, non staccate i fili conduttivi dell'antenna a quadro dai terminali.

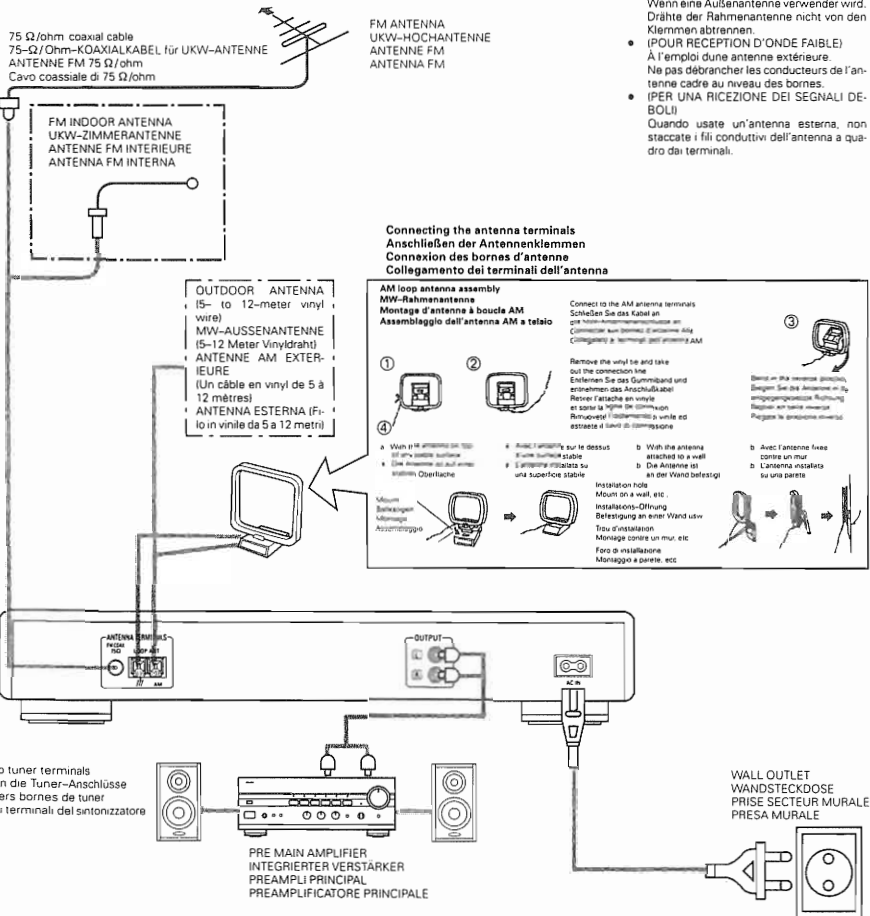

**Note:**  
• Please keep away AM loop antenna from the metal parts of the back panel.

**Hinweis:**  
• Die MW-Rahmenantenne (AM) darf die Metallteile der Geräte-Rückseite nicht berühren.

**Remarque:**  
• Eloigner l'antenne en boucle AM de toute partie métallique du panneau arrière.

**Nota:**  
• Tenete lontana antenna AM a quadro dalle parti metalliche del pannello posteriore.

**DESIGNATIONS AND FUNCTIONS OF PANEL CONTROLS (Refer to Page 3.)**

**FRONT PANEL / REMOTE CONTROL UNIT**

- ON / STANDBY button**  
The unit works 2-3 seconds after this switch is turned on. Whenever the power switch is in the STANDBY state, the apparatus is still connected on AC line voltage. Please be sure to unplug the cord when you leave home for, say, a vacation.
- Remote control sensor (REMOTE SENSOR)**  
This sensor receives the infrared light transmitted from the wireless remote control unit. For remote control, point the wireless remote control unit to the sensor. Some of the functions can be operated with the remote control unit RC-824.
- IF BAND button**  
Use this button to select the bandwidth of the FM intermodulation frequency amplifier "WIDE" or "NARROW". The wide or narrow position is indicated by the WIDE/NARROW indicator.
- SHIFT / PTY button**  
Use this button to select the memory blocks, A (1 to 8), B (1 to 8), C (1 to 8), D (1 to 8), or E (1 to 8). For PTY search and EON PTY, use this button to select the program type. When writing station names, use this button to set the writing position.
- MEMORY button**  
Frequencies and station names can be stored in the memory. When this button is pressed, the "MEMO" and "CH" indicator on the display flashes for 10 seconds. Use the SHIFT/PTY button and the preset channel buttons during this time to designate the desired preset channel.
- TUNING / PRESET button**  
Each press of this button toggles the operation mode of the TUNING/PRESET control. In the TUNING mode, the "TUNING" indication of the fluorescent display tube is lit. In the PRESET mode, the "PRESET" indication of the fluorescent display tube is lit.
- TUNING / PRESET control**  
This control is used in conjunction with the TUNING/PRESET button. In the TUNING mode (when "TUNING" is lit in the fluorescent display tube), the reception frequency is tuned up or down. Turning the control in the clockwise direction tunes the frequency up. Turning the control in the counterclockwise direction tunes the reception frequency down. In the PRESET mode (when "PRESET" is lit in the fluorescent display tube), the selection of the preset channel is moved up or down. The AUTO TUNING operation cannot be used when in this mode. When writing station names, use this control to select the letters. (Refer to Page 5.)
- Tuning mode button (AUTO/MANU)**  
This switch between auto and manual tuning. Auto tuning: (The "AUTO" indicator lights.) Auto tuning is used to receive FM broadcasts in stereo. Depending on the mode of the broadcast and the strength of the signal, auto tuning will automatically switch the receiving mode to stereo or monaural. During tuning, the frequency is automatically tuned up or down. Manual tuning: The broadcast is received in monaural regardless of the mode of the FM broadcast. The reception mode should be set to "MANUAL" when there is noisy reception of stereo broadcasts (which are indicated by the lighting of "AUTO") and also when the signal is weak. During tuning, the reception frequency is tuned up or down only when the tuning mode control (marked TUNING / PRESET) is used.
- EON TA button**  
This button is used to turn EON TA mode on or off. (Refer to Page 12.)
- EON PTY button**  
This button is used to turn EON PTY mode on or off. (Refer to Page 13.)
- BAND button**  
Selects FM or MW (AM).
- Radio Text button (RT)**  
This button is used for displaying radio text messages. When this button is pressed while the station currently tuned in is offering a radio text message service, the message scrolls on the display. This mode turns on and off each time the button is pressed.
- Display mode selector button (DISPLAY)**  
This button is used to select the display mode. The mode changes as follows each time the button is pressed:  
• Tuning frequency  
• Input character  
• Programme service name (PS)  
• Programme type (PTY)  
• Clock time (CT)  
The following may be displayed if the signals are weak or no RDS service is available. This is not a malfunction.  
"NO PS"  
"NO PTY"  
"NO TIME DATA"  
**NOTE:** The programme type, programme service name and clock time are not displayed in the MW (AM) band. "NO TIME DATA" may be displayed within the first minute after a station is tuned in, but this is not a malfunction. If time data is being broadcast, the time can be displayed after one minute has passed.

**TUNING buttons (REMOTE CONTROL UNIT)**  
Use these to change the received frequency to a higher frequency (UP) or a lower frequency (DOWN).

**CAUTION:**  
1. Whenever the ON / STANDBY button is in the STANDBY position, the unit is still connected on AC line voltage. Please be sure to unplug the cord when you leave home for, say, a vacation.  
2. Noise may be generated if a near-by television set is on during MW (AM), FM broadcasting reception. The tuner should be used as far away from a television as possible.  
3. Effective period of memory back-up is about a month under normal temperature.

**NOTE:**  
The buttons on the remote control unit marked "※" do not function on this model. (Nothing will happen when they are pressed.)

#### 14 RF attenuator button (RF ATT)

This button turns the RF attenuator on and off. When the RF attenuator is on, the "RF ATT" indicator on the display lights, and the antenna input signals are attenuated before entering the front end. Turn the RF attenuator on to receive local stations and when connecting to a cable system. Turn the RF attenuator off to receive weak signals.

This mode only functions in the FM band. This mode setting is stored in the preset memory.

### REAR PANEL

#### 17 FM antenna terminals (ANTENNA TERMINAL FM)

75-Ω/ohm coaxial cables can be connected to these terminals. For the connection procedure, see the section "CONNECTIONS". (Refer to Page 6.)

#### 18 AM antenna terminals (ANTENNA TERMINAL AM/T77)

Connect the included AM loop antenna. (Refer to Page 6 for connections.) Connect with this terminal when a medium wave outdoor antenna is used.

### DISPLAY

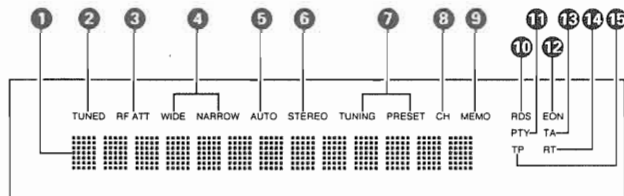

#### 1 5 x 7 dot matrix display

This displays the frequency, station name, program type, etc.

#### 2 TUNED indicator

This lights when a station is properly tuned in.

#### 3 RF ATT indicator

This lights when the RF attenuator is turned on (RF ATT 14).

#### 4 WIDE/NARROW indicator

This lights whether if amplifier stage is wide on narrow.

#### 5 AUTO indicator

This indicates the tuning mode. It lights in the auto mode, and remains off in the manual mode.

#### 6 STEREO indicator

This lights when receiving stereo broadcasts. It remains off when receiving AM broadcasts.

#### 7 TUNING/PRESET indicator

This displays the operation mode of TUNING/PRESET button 9.

#### 8 CH indicator

This lights when the preset channel number is displayed, and flashes during the auto preset memory operation and memory operation.

#### 15 Search character mode button (SEARCH/CHARACTER)

This button is used for the RDS search (refer to Page 11), PTY search (refer to Page 12) and TP search (refer to Page 12) operations, and to input the station name (refer to Page 11).

#### 16 Preset channel button (1-8)

Use these when presetting and recalling stations. Also use these with the SHIFT/PTY button to use a total of 40 preset channels, A (1-8), B (1-8), ... E (1-8).

#### 19 Output terminals (OUTPUTS)

Connect these to the TUNER input terminals on the pre-main amplifier.

#### 20 AC Inlet

Connect the included AC cord here.

#### 9 MEMO indicator

This flashes for 10 seconds when the MEMORY button 8 is pressed, and flashes during the auto preset memory operation.

#### 10 RDS indicator

This lights when receiving RDS broadcasts, and flashes during the RDS search.

#### 11 PTY indicator

This lights when the EON PTY button is pressed, and flashes during the PTY search operation.

#### 12 EON indicator

This lights when receiving EON information.

#### 13 TA indicator

This lights when the EON TA button is pressed and when a traffic announcement is being received.

#### 14 RT indicator

This lights when the RT button is pressed.

#### 15 TP indicator

This lights when receiving a station broadcasting traffic announcements and flashes during the TP search operation.

### PLAYBACK USING THE REMOTE CONTROL

The accessory RC-824 remote control unit is used to control the Tuner from a distance.

#### (1) Inserting the dry cell batteries

1. Remove the rear cover on the remote control unit.



2. Insert two size R6 (AA) dry cell batteries as shown in the diagram on the battery supply unit.



3. Replace the rear cover.



#### (2) Directions for use



#### Notes on Use of the Batteries

- The remote control unit uses size R6 (AA) dry cell batteries.
- The batteries will need to be replaced approximately once a year. This will depend upon how often the remote control is used.
- If, in less than a year from the time new batteries were inserted, the remote control fails to operate the Tuner from a near-by position, it is time to replace the batteries.
- Insert the batteries properly, following the diagram on the remote control battery supply unit, and making sure to align the plus and minus sides of each battery.
- Batteries are prone to damage and leakage. Therefore:
  - Do not combine new batteries with used ones.
  - Do not combine different types of batteries.
  - Do not jumper the opposite poles of the batteries, expose them to heat or break them open, or put them into open fire.
- When the remote control is not to be used for a long period of time, remove the batteries from the unit.
- If the batteries have leaked, remove any battery fluid from the inside of the battery supply unit by wiping it out thoroughly, and insert new batteries.

- Operate the remote control unit while pointing it towards the remote control sensor on the Tuner as shown in the diagram left.
- The remote control unit can be used at distances up to about 8 meters in a straight line from the Tuner. This distance will decrease if there are obstructions blocking the infra-red light transmission or if the remote control unit is not directed straight at the Tuner.

#### Note on Operation

- Do not press the operating buttons on the Tuner and the remote control unit at the same time. This will cause misoperation.
- Operation of the remote control unit will become less effective or erratic if the infrared remote control sensor on the Tuner is exposed to strong light or if there are obstructions between the remote control unit and the sensor.
- In case you operate your VCR, TV or other components by remote control, do not operate buttons on two different remote control units at the same time. This will cause mis-operation.

## Using the Various Functions

### 1. Using the auto preset memory function

This function automatically stores the FM stations which can be received in the area in which the set is being used in the preset memory. Use this function so that the RDS functions can be used more effectively. Also note that the channel memories can be changed at will even after the preset stations have been stored with this function.

#### Operation

1. Connect the FM antenna and set it so that FM stations can be received.
2. Press the ON/STANDBY button to turn on the power while holding in the MEMORY button.
3. Searching begins automatically, and stations are stored in the preset memory in order, beginning from channel A1. (The operation automatically stops once 40 stations have been set in the memory.)

### 2. Storing new stations at the preset channels

The reception frequency, RDS service information, Tuning mode, RF ATT mode and input characters can be stored at the different channel memories.

When this operation is performed, the station already stored in that channel memory using the auto preset memory function is cleared.

#### Operation

1. Press the MEMORY button. (The CH and MEMO indicator flash.)
2. Use the SHIFT/PTY button to select the block, A to E.
3. Use buttons 1 to 8 to select the channel at which the station is to be stored.

### 3. Recalling preset channels

Use the following operation to recall preset channels:

#### Operation

1. Use the SHIFT/PTY button to select the block, A to E.
2. Use buttons 1 to 8 to select the channel at which to store the station.

### 4. Inputting characters

Some characters can be input (up to 8 characters).

The input characters can be stored at the preset channels.

#### Operation

1. Press the SEARCH/CHARACTER button four times. (The cursor flashes at the first place.)



2. Use the TUNING/PRESET control to select the character for the first place. (The selected character flashes.)



3. Press the SHIFT/PTY button to move the cursor to the next place. (The cursor flashes at the second place.)

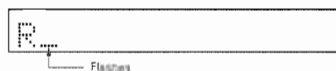

4. Repeat steps 2 and 3 above to input up to 8 characters.

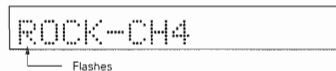

5. The characters are set five seconds after the input procedure is finished. The input characters can be stored in the memory. To keep the input characters, be sure to store them in a channel memory.

6. Clearing characters

1. Recall the character you want to clear.
2. Press the SEARCH/CHARACTER button 4 times until the character at the first place flashes.
3. Then press the SHIFT/PTY button for at least 2 seconds. The current character will then be cleared.

## Using the RDS Functions (for FM only)

### 1. RDS Search

Use this to automatically search and stop at stations offering RDS services.

#### Operation

1. Press the SEARCH/CHARACTER button once.

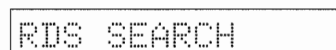

2. Turn the TUNING/PRESET control clockwise or counterclockwise. (Searching begins.)



3. Searching starts again when the TUNING/PRESET control is turned clockwise or counterclockwise while the RDS indicator is flashing.

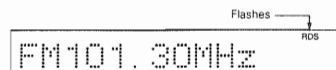

4. If no other RDS station is found when all the frequencies are searched, "NO RDS" is displayed.

### 2. PTY Search

Use this to automatically search and stop at stations broadcasting the specified programme type (PTY).

#### Operation

1. Press the SEARCH/CHARACTER button twice.

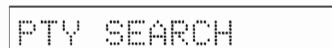

2. Use the SHIFT/PTY button to select the programme type.

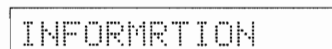

3. Turn the TUNING/PRESET control clockwise or counterclockwise. (Searching begins.)



4. Searching starts again when the TUNING/PRESET control is turned clockwise or counterclockwise while the PTY indicator is flashing.

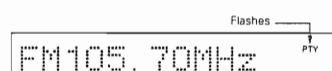

5. If no other station broadcasting the designated programme type is found when all the frequencies are searched, "NO PROGRAMME" is displayed.

#### List of PTY (Programme Type) Displays

1. NEWS	9. VARIED
2. AFFAIRS	10. POP MUSIC
3. INFORMATION	11. ROCK MUSIC
4. SPORT	12. M.O.R. MUSIC
5. EDUCATION	13. L-CLASSICS (Light classics)
6. DRAMA	14. S-CLASSICS (Serious classics)
7. CULTURE	15. OTHER MUSIC
8. SCIENCE	31. ALARM

**NOTE:** ALARM cannot be selected during the PTY search operation and when in the EON PTY mode.

### 3. TP Search

Use this to automatically search and stop at stations which broadcast traffic announcements (even if the station is not currently broadcasting a traffic announcement).

#### Operation

1. Press the SEARCH/CHARACTER button three times.

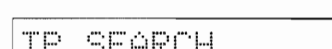

2. Turn the TUNING/PRESET control clockwise or counterclockwise. (Searching begins.)



3. Searching starts again when the TUNING/PRESET control is turned clockwise or counterclockwise while the TP indicator is flashing.

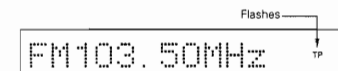

4. If no other TP station is found when all the frequencies are searched, "NO PROGRAMME" is displayed.

### 4. Radio Text (RT)

When this button is pressed while the station currently tuned in is offering a radio text message service, the message scrolls on the display.

(The RT indicator lights when the RT button is pressed.)

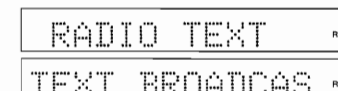

("NO TEXT DATA" is displayed if no radio text message is being broadcast.)

### 5. EON TA

When an RDS station is broadcasting RDS information on other stations within the same network and a traffic announcement begins on another station in the same network based on this information (EON = Enhanced Other Network), that network station is automatically tuned in. The previous station is tuned back in once the traffic announcement is over.

#### Operation

1. Press the EON TA button. (The TA indicator lights.)

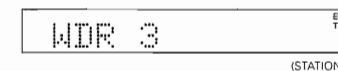

(When a traffic announcement starts, that station is automatically tuned in.)

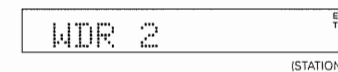

(When the traffic announcement is over, the previous station is tuned back in.)

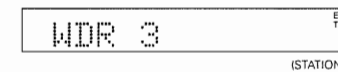

**NOTE:**

If the station switches from the current station to the network station when this mode is on but the network station cannot be received properly due to weak signals, the previous station is immediately tuned back in.

## 6. EON PTY

When an RDS station is broadcasting RDS information on other stations within the same network and a programme of the specified programme type (PTY) begins on a station in the same network, that network station is automatically tuned in. Use this function to tune in broadcasts of the desired programme type with priority.

### Operation

- Press the EON PTY button, and use the SHIFT/PTY button to select the programme type.

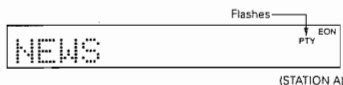

This mode is set five seconds after the programme type is selected.

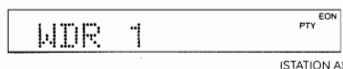

(When a programme of the specified programme type begins on a station in the same network, that station is tuned in.)

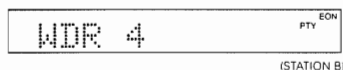

(The previous station is tuned back in once a programme of a different programme type begins.)

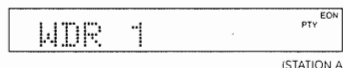

- To change the programme type, first press the EON PTY button to cancel the EON PTY mode then set it again.

### NOTE:

If the station switches from the current station to the network station broadcasting the specified programme type when this mode is on but the network station cannot be received properly due to weak signals, the previous station is immediately tuned back in.

### NOTES:

- Be sure to turn the EON TA and EON PTY modes off when recording programmes.
- In the EON TA and EON PTY modes, if the station is switched from the current station to another station in the network but the signals of that network station are weak and it cannot be tuned in properly, "WEAK SIGNAL" is displayed and the original station is immediately tuned back in.
- In the EON TA mode, the station does not switch to another station in the network if the current station is broadcasting a traffic announcement.
- In the EON PTY mode, the station does not switch to another station in the network if the current station is broadcasting a programme of the same programme type.
- Since the RDS services offered differ from station to station, some RDS functions may not operate for some stations, but this is not a malfunction.

## TROUBLESHOOTING

Check the following before assuming there is a problem with the set.

- Are all connections proper?
- Is the set being operated as described in the operating instructions?
- Are the speakers and input components being operated properly?





If the set does not seem to be operating properly, check the points listed below. If these points do not apply, the set may be damaged. Turn off the power immediately and contact your store of purchase.

Symptom	Cause	Measures	Page
Power does not turn on when ON/STANDBY button is pressed.	<ul style="list-style-type: none"> <li>Power cord's plug is not plugged in to wall outlet.</li> </ul>	<ul style="list-style-type: none"> <li>Plug the power cord in properly.</li> </ul>	6
Hissing noise is heard on FM broadcasts.	<ul style="list-style-type: none"> <li>Antenna cable is not properly connected</li> <li>Antenna is not pointing in the right direction.</li> <li>Radio waves are weak.</li> </ul>	<ul style="list-style-type: none"> <li>Connect the leads properly.</li> <li>Point the antenna in the right direction.</li> <li>Install an outdoor antenna.</li> </ul>	6 6 6
Hissing or buzzing sound is heard on AM broadcasts.	<ul style="list-style-type: none"> <li>Noise from a TV or interference in the signals sent from the broadcast station.</li> </ul>	<ul style="list-style-type: none"> <li>Turn off the TV.</li> <li>Change the position of the loop antenna.</li> <li>Install an outdoor antenna.</li> </ul>	6 6 6
Booming sound (humming) is heard in AM broadcasts.	<ul style="list-style-type: none"> <li>Signals transmitted over the power cord are modulated by the power source frequency.</li> </ul>	<ul style="list-style-type: none"> <li>Insert the plug in the opposite direction.</li> <li>Install an outdoor antenna.</li> </ul>	6 6
Nothing happens when remote control buttons are pressed.	<ul style="list-style-type: none"> <li>Are the batteries dead?</li> <li>Is the remote control unit too far away?</li> <li>Is there an obstacle between the remote control unit and the main unit?</li> <li>You have pressed the wrong button.</li> <li>Batteries are not set in their proper direction (⊕ and ⊖).</li> </ul>	<ul style="list-style-type: none"> <li>Replace the batteries with new ones.</li> <li>Operate from closer to the main unit.</li> <li>Remove the obstacle.</li> <li>Press the desired button.</li> <li>Set the batteries in the proper direction.</li> </ul>	10 10 10 10 10





Technical Data (typical value)	
<b>FM SECTION</b>	
Frequency Range	87.5 MHz – 108.0 MHz
Antenna Terminals	75 Ω / ohm Unbalanced
Usable Sensitivity	0.9 μV (110.3 dBf) 1.2 μV (IHF)
S/N 50 dB Sensitivity	
Monaural	1.6 μV (115.3 dBf)
Stereo	2.0 μV (137.2 dBf)
IHF is at 75 Ω / ohm	
0 dBf = 10 <sup>-15</sup> W	
Image Interference Ratio	80 dB
IF Interference Ratio	100 dB
AM Suppression Ratio	50 dB
Effective Selectivity	
WIDE	50 dB (± 400 kHz)
NARROW	60 dB (± 300 kHz)
Capture Ratio	1.5 dB
Frequency Characteristics	20 Hz – 15 kHz -0.5 dB
Signal-to-noise Ratio	
Monaural	82 dB (IHF) 78 dB (IDI)
Stereo	78 dB (IHF) 74 dB (IDI)
Total Harmonic Distortion (WIDE)	
Mono 1 kHz	0.08%
(at 75 kHz dev.)	
Stereo 1 kHz	0.12%
(at 67.5 kHz dev.)	
Stereo Separation 1 kHz (WIDE)	50 dB
<b>AM (MW) SECTION</b>	
Frequency Range	522 kHz – 1611 kHz
Antenna Terminals	Terminal Type with Loop Ant
Usable Sensitivity	18 μV
Signal-to-noise Ratio	53 dB
<b>OTHERS</b>	
Power Supply	AC 230 V 50 Hz
Power Consumption	9 W
Dimensions (W) × (H) × (D)	434 × 75 × 242 mm
Net Weight	2.5 kg
<b>REMOTE CONTROL UNIT (RC-824)</b>	
Remote control system	
Infrared pulse system	
Power supply	3V DC, Two size R6P ("AA") dry cell batteries
External dimensions (W) × (H) × (D)	48 × 177 × 18 mm
Weight	100 g (including batteries)

• Design and specifications are subject to change without prior notice.

### • SAFETY PRECAUTIONS

	<b>CAUTION</b> RISK OF ELECTRIC SHOCK DO NOT OPEN	
<b>CAUTION: TO REDUCE THE RISK OF ELECTRIC SHOCK, DO NOT REMOVE COVER (OR BACK). NO USER SERVICEABLE PARTS INSIDE. REFER SERVICING TO QUALIFIED SERVICE PERSONNEL.</b>		
	The lightning flash with arrowhead symbol, within an equilateral triangle, is intended to alert the user to the presence of uninsulated "dangerous voltage" within the product's enclosure that may be of sufficient magnitude to constitute a risk of electric shock to persons.	
	The exclamation point within an equilateral triangle is intended to alert the user to the presence of important operating and maintenance (servicing) instructions in the literature accompanying the appliance.	
<b>WARNING: TO REDUCE THE RISK OF FIRE OR ELECTRIC SHOCK, DO NOT EXPOSE THIS APPLIANCE TO RAIN OR MOISTURE.</b>		

### • 安全注意事項

	<b>CAUTION</b> RISK OF ELECTRIC SHOCK DO NOT OPEN	
<b>注意：為減少觸電危險，切勿拆下機殼（或機背）。機身內並無用戶修理用零件。請交由專業修理人員修理本機。</b>		
	三角形內有箭頭的閃電符號旨在提醒用戶，本產品機殼內有未經絕緣的“危險電壓”，其幅度足以使人觸電而發生危險。	
	三角形內加感嘆號旨在提醒用戶，有重要的操作與維修說明書配合本機。	
<b>警告：為減少着火或觸電危險，切勿讓本機受雨淋濕或受潮。</b>		







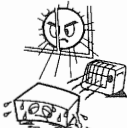

### CONTENTS

1. NOTE ON USE .....	3
2. NAMES AND FUNCTION OF PARTS .....	4, 5
3. CONNECTIONS .....	6
4. USING THE VARIOUS FUNCTIONS .....	7
5. TROUBLESHOOTING .....	8
6. SPECIFICATIONS .....	14

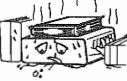

### 目錄

1. 使用注意事項 .....	3
2. 部件名稱及功能 .....	9、10
3. 聯接 .....	11
4. 各種功能的使用 .....	12
5. 故障診斷 .....	13
6. 規格 .....	14

### NOTE ON USE

		
• Avoid high temperatures. Allow for sufficient heat dispersion when installed on a rack.	• Keep the set free from moisture, water, and dust.	• Do not let foreign objects in the set.
		
• Handle the power cord carefully. Hold the plug when unplugging the cord.	• Unplug the power cord when not using the set for long periods of time.	• Do not let insecticides, benzene, and thinner come in contact with the set.
		
• Handle the power cord carefully. Hold the plug when unplugging the cord.	* (For sets with ventilation holes) • Do not obstruct the ventilation holes.	• Never disassemble or modify the set in any way.

### 使用注意事項

		
<b>防止高溫</b> • 勿將本機放置於受烈日曝曬或靠近發熱器材的位置。 <b>機架/鐵箱安裝注意</b> • 避免將本機裝於密閉的機架內。 • 裝於機架或鐵箱時，要配備足夠大的通風孔，以加強散熱。	<b>注意蒸汽、水和塵</b> • 勿將本機放置於溫度很高或多塵的位置。花瓶或其它有水的物件均不宜擺在本機上方。	<b>勿讓雜物掉入機內</b> • 特別要注意勿讓針、髮夾、硬幣等進入本機。
		
<b>留意電源線</b> • 從插頭拔出插頭時切勿拔電源線，應該抓住插頭將其拔出。	<b>當你外出時</b> • 長時間不用本機時，例如外出旅行時，須將插頭拔離電源插座。	<b>保護機殼</b> • 避免在本機附近噴灑殺蟲劑，也勿用汽油天拿水或其它溶劑抹機殼，因這類溶劑易引起品質或顏色改變。抹應用軟布，在用化學處理過的布指抹時請小心遵守說明書規定。
		
• 從插頭拔出插頭時切勿拔電源線，應該抓住插頭將其拔出。	* 備有通風孔的機殼 <b>勿堵塞機殼的通風孔</b> • 堵塞通風孔會損壞本機。 • 各通風孔對本機內部散熱異常重要。必須特別留意。若通風孔有物件阻擋，就會使機內溫度升得過高。	<b>勿打開機殼</b> • 打開機殼頂蓋或底板，及伸手入機殼內部是危險的。切勿打開機殼。如果本機表現有不妥當時，在立刻放下電源插頭，再與購入本機的商店或鄰近經銷商聯絡。



Please check to make sure the following items are included with the main unit in the carton:

- (1) Operating Instructions .....1
- (2) AC Cord .....1
- (3) Connecting Cord .....1
- (4) AM Loop Antenna .....1
- (5) FM Indoor Antenna .....1
- (6) Service Station List .....1

#### Table of characters

The characters are input in the order shown below. Use the TUNING/PRESET control ⑫ to select the desired characters.

A,B,C,D,E,F,G,H,I,J,K,L,M,N,O,P,Q,R,S,T,U,V,W,X,  
Y,Z,0,1,2,3,4,5,6,7,8,9,[ \ ] ^ \_ ` " # \$ % & ' ( ) \* + , - . / : ; < = > ? (space)

### NAMES AND FUNCTION OF PARTS

#### FRONT PANEL



#### REAR PANEL

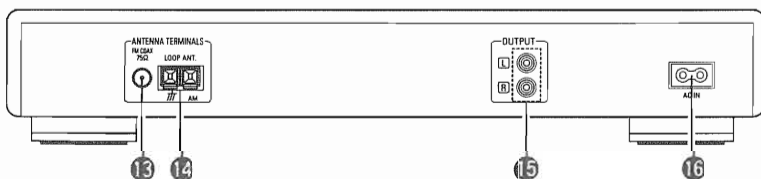

#### FRONT PANEL

- ① ON/STANDBY button**  
The unit works 2-3 seconds after this button is turned on. Whenever the ON/STANDBY button is in the STANDBY state, the apparatus is still connected on AC line voltage. Please be sure to unplug the cord when you leave home for, say, a vacation.
- ② Tuning mode button (AUTO/MANU)**  
This switches between auto and manual tuning. Auto tuning: (The "AUTO" indicator lights) Auto tuning is used to receive FM broadcasts in stereo. Depending on the mode of the broadcast and the strength of the signal, auto tuning will automatically switch the receiving mode to stereo or monaural. During tuning, the frequency is automatically tuned up or down. Manual tuning: The broadcast is received in monaural regardless of the mode of the FM broadcast. The reception mode should be set to "MANUAL" when there is noisy reception of stereo broadcasts (which are indicated by the lighting of "STEREO") and also when the signal is weak. During tuning, the reception frequency is tuned up or down only when the TUNING/PRESET control ⑫ (marked TUNING/PRESET) is used.
- ③ BAND button**  
Selects FM or MW (AM).

- ④ Display mode selector button (DISPLAY)**  
This button is used to select the display mode. The mode changes as follows each time the button is pressed:
  - Tuning frequency
  - Input character
- ⑤ Character mode button (CHARACTER)**  
This button is used to input the station name. (Refer to page 7)
- ⑥ Remote control sensor (REMOTE SENSOR)**  
This sensor receives the infrared light transmitted from the wireless remote control unit. For remote control, point the wireless remote control unit at the sensor. Some of the functions can be operated with the remote control units included with DENON pre-main amplifiers and AV surround amplifiers.
- ⑦ Preset channel button (1-8)**  
Use these when presetting and recalling stations. Also use these with the SHIFT button to use a total of 40 preset channels, A (1-8), B (1-8), ... E (1-8).

- ⑧ IF BAND button**  
Use this button to select the bandwidth of the FM intermediate frequency amplifier "WIDE" or "NARROW". The wide or narrow position is indicated by the WIDE/NARROW indicator ③.  
**⑨ SHIFT button**  
Use this button to select the memory blocks, A (1 to 8), B (1 to 8), C (1 to 8), D (1 to 8), or E (1 to 8). When writing station names, use this button to set the writing position.  
**⑩ MEMORY button**  
Frequencies and station names can be stored in the memory. When this button is pressed, the "MEMO" and "CH" indicator on the display flashes for 10 seconds. Use the SHIFT button and the channel buttons during this time to designate the desired preset channel.  
**⑪ TUNING/PRESET button**  
Each press of this button toggles the operation mode of the TUNING/PRESET control ⑫.

#### CAUTION:

1. Whenever the ON/STANDBY button is in the STANDBY position, the unit is still connected on AC line voltage. Please be sure to unplug the cord when you leave home for, say, a vacation.
2. Noise may be generated if a near-by television set is on during MW (AM), FM broadcasting reception. The tuner should be used as far away from a television as possible.
3. Effective period of memory back-up is about a month under normal temperature.

In the TUNING mode, the "TUNING" indication of the fluorescent display tube is lit. In the PRESET mode, the "PRESET" indication of the fluorescent display tube is lit.

- ⑫ TUNING/PRESET control**  
This control is used in conjunction with the TUNING/PRESET button ⑪. In the TUNING mode (when "TUNING" is lit in the fluorescent display tube), the reception frequency is tuned up or down. Turning the control in the clockwise direction tunes the frequency up. Turning the control in the counterclockwise direction tunes the reception frequency down. In the PRESET mode (when "PRESET" is lit in the fluorescent display tube), the selection of the preset channel is moved up or down. The AUTO TUNING operation cannot be used when in this mode. When writing station names, use this control to select the letters. (Refer to Page 7)

#### REAR PANEL

- ⑬ FM antenna terminals (ANTENNA TERMINAL FM)**  
75-Ω/ohms coaxial cables can be connected to these terminals. For the connection procedure, see the section "CONNECTIONS". (Refer to Page 6)
- ⑭ AM antenna terminals (ANTENNA TERMINAL AM/GND)**  
Connect the included AM loop antenna. (Refer to page 6 for connections)
- ⑮ Output terminals (OUTPUT)**  
Connect these to the TUNER input terminals on the pre-main amplifier.
- ⑯ AC Inlet (AC IN)**  
Connect the included AC cord here.

Connect this terminal when a medium wave outdoor antenna is used.

#### DISPLAY

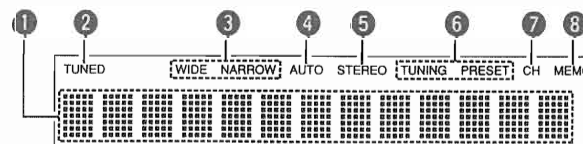

- ① 5 X 7 dot matrix display**  
This displays the frequency, station name, program type, etc.
- ② TUNED indicator**  
This lights when a station is properly tuned in.
- ③ WIDE/NARROW indicator**  
This lights whether if amplifier stage is wide on narrow.
- ④ AUTO indicator**  
This indicates the tuning mode. It lights in the auto mode, and remains off in the manual mode.
- ⑤ STEREO indicator**  
This lights when receiving stereo broadcasts. It remains off when receiving AM broadcasts.
- ⑥ TUNING/PRESET indicator**  
This displays the operation mode of TUNING/PRESET button ⑪.
- ⑦ CH indicator**  
This lights when the preset channel number is displayed, and flashes during the auto preset memory operation and memory operation.
- ⑧ MEMO indicator**  
This flashes for 10 seconds when the MEMORY button ⑩ is pressed, and flashes during the auto preset memory operation.

## CONNECTIONS

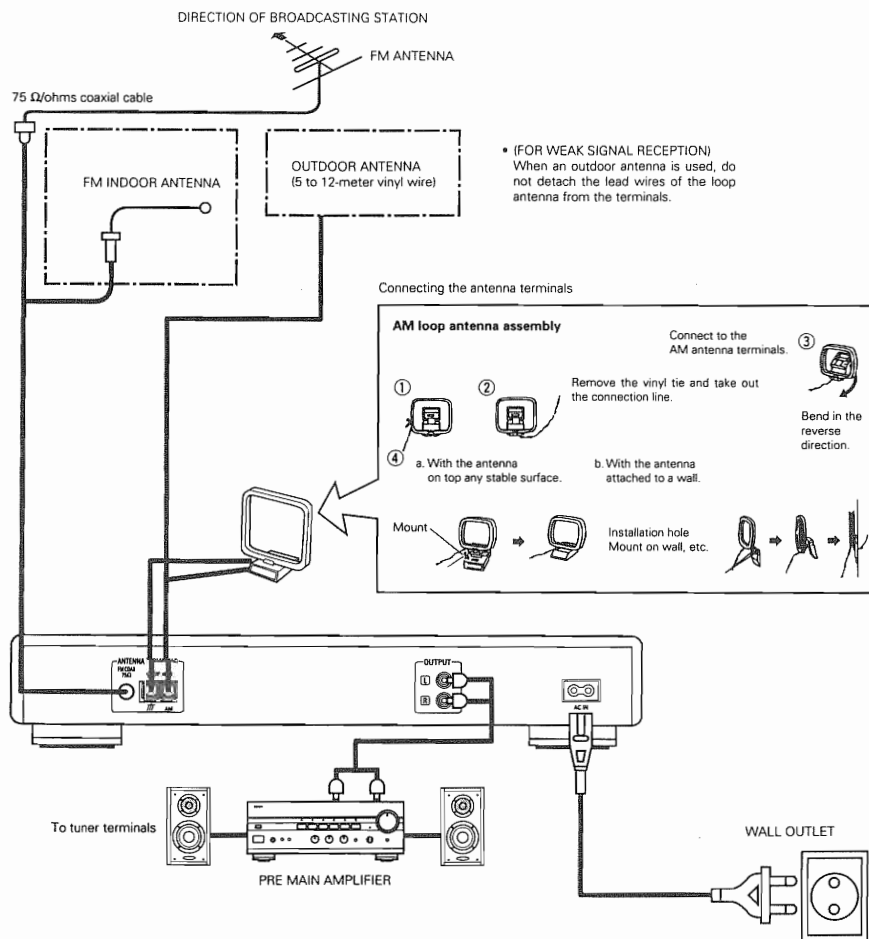
**Note:**

- Please keep away AM loop antenna from the metal parts of the back panel.

## Using the Various Functions

**1. Using the auto preset memory function**

This function automatically stores the FM stations which can be received in the area in which the set is being used in the preset memory.

**Operation**

1. Connect the FM antenna and set it so that FM stations can be received.
2. Press the ON/STANDBY button to turn on the power while holding in the MEMORY button.
3. Searching begins automatically, and stations are stored in the preset memory in order, beginning from channel A1. (The operation automatically stops once 40 stations have been set in the memory.)

**2. Storing new stations at the preset channels**

The reception frequency, Tuning mode and input characters can be stored at the different channel memories. When this operation is performed, the station already stored in that channel memory using the auto preset memory function is cleared.

**Operation**

1. Press the MEMORY button. (The MEMO indicator flashes.)
2. Use the SHIFT button to select the block, A to E.
3. Use buttons 1 to 8 to select the channel at which the station is to be stored.

**3. Recalling preset channels**

Use the following operation to recall preset channels:

**Operation**

1. Use the SHIFT button to select the block, A to E.
2. Use buttons 1 to 8 to select the channel at which to store the station.

**4. Inputting characters**

Some characters can be input (up to 8 characters). The input characters can be stored at the preset channels.

**Operation**

1. Press the CHARACTER button four times. (The cursor flashes at the first place.)

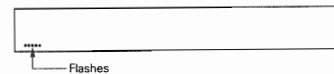

2. Use the TUNING/PRESET control to select the character for the first place. (The selected character flashes.)

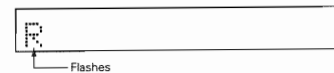

3. Press the SHIFT button to move the cursor to the next place. (The cursor flashes at the second place.)



4. Repeat steps 2 and 3 above to input up to 8 characters.

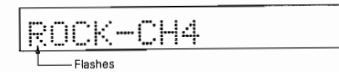

5. The characters are set five seconds after the input procedure is finished. The input characters can be stored in the memory. To keep the input characters, be sure to store them in a channel memory.

6. Clearing characters.

1. Recall the character you want to clear.
2. Press the CHARACTER button 4 times until the character at the first place flashes.
3. Then press the SHIFT button for at least 2 seconds. The current character will be cleared.

## TROUBLESHOOTING

Check the following before assuming there is a problem with the set.

1. Are all connections proper ?
2. Is the set being operated as described in the operating instructions ?
3. Are the speakers and input components being operated properly ?

If the set does not seem to be operating properly, check the points listed below. If these points do not apply, the set may be damaged. Turn off the power immediately and contact your store of purchase.

Symptom	Cause	Measures	Page
Power does not turn on when ON/STANDBY button is pressed.	<ul style="list-style-type: none"><li>• Power cord's plug is not plugged in to wall outlet.</li></ul>	<ul style="list-style-type: none"><li>• Plug the power cord in properly.</li></ul>	6
Hissing noise is heard on FM broadcasts.	<ul style="list-style-type: none"><li>• Antenna cable is not properly connected.</li></ul>	<ul style="list-style-type: none"><li>• Connect the leads properly.</li></ul>	6
	<ul style="list-style-type: none"><li>• Antenna is not pointing in the right direction.</li></ul>	<ul style="list-style-type: none"><li>• Point the antenna in the right direction.</li></ul>	6
	<ul style="list-style-type: none"><li>• Radio waves are weak.</li></ul>	<ul style="list-style-type: none"><li>• Install an outdoor antenna.</li></ul>	6
Hissing or buzzing sound is heard on AM broadcasts.	<ul style="list-style-type: none"><li>• Noise from a TV or interference in the signals sent from the broadcast station.</li></ul>	<ul style="list-style-type: none"><li>• Turn off the TV.</li></ul>	6
		<ul style="list-style-type: none"><li>• Change the position of the loop antenna.</li></ul>	6
		<ul style="list-style-type: none"><li>• Install an outdoor antenna.</li></ul>	6
Booming sound (humming) is heard in AM broadcasts.	<ul style="list-style-type: none"><li>• Signals transmitted over the power cord are modulated by the power source frequency.</li></ul>	<ul style="list-style-type: none"><li>• Insert the plug in the opposite direction.</li></ul>	6
		<ul style="list-style-type: none"><li>• Install an outdoor antenna.</li></ul>	6

MEMO:

## METHOD OF ADJUSTMENT

### CONNECTION DIAGRAM OF MESURING INSTRUMENTS

When making adjustments, be sure the power supply is at the rated voltage and the room air is on normal conditions with respect to temperature and humidity.

● FM

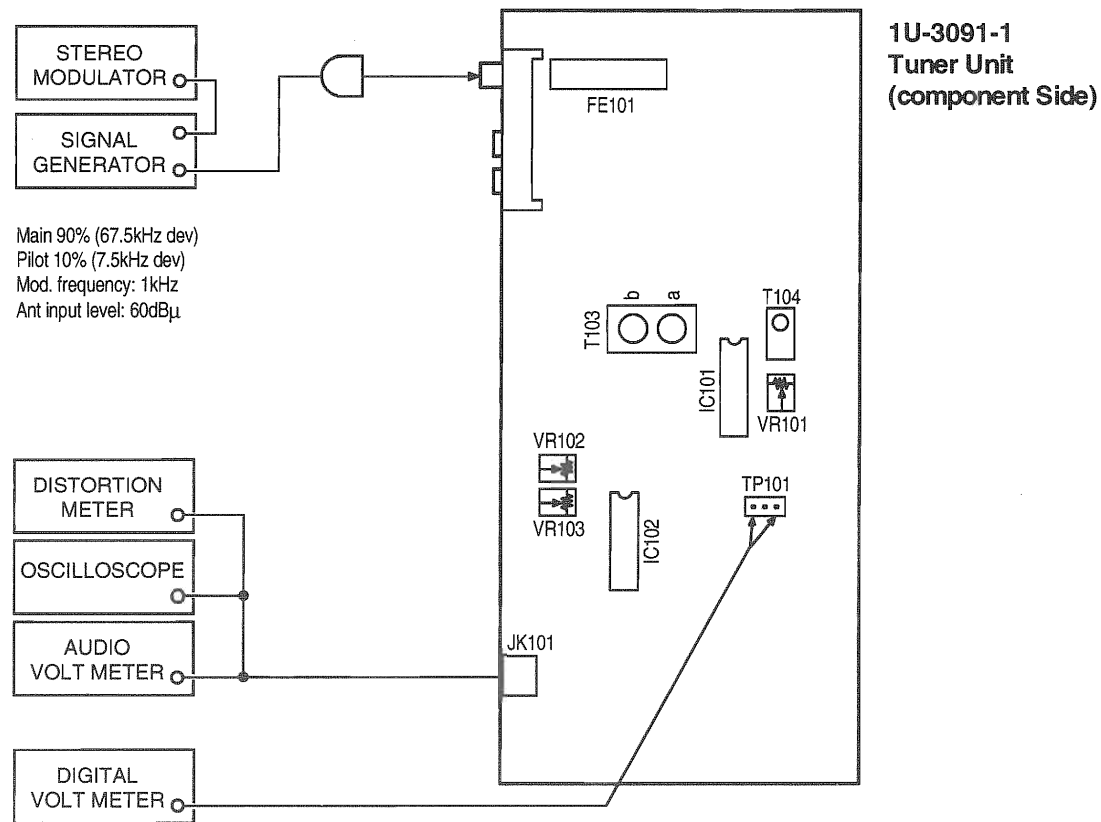

### 1U-3091-1 TUNER UNIT FM Alignment Points (Component Side)

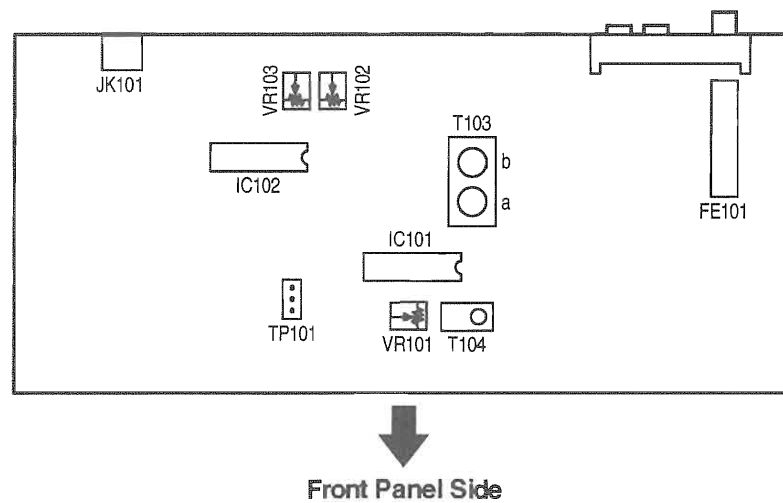

## FM ALIGNMENT

Item	Alignment Item	Tuning Frequency Setting	Input				Output			Adjustment		Remarks
			Type	Frequency	Input Level	Modulation	Type	Connect to	Points	Adjust to		
1	Center Adjustment	98 MHz	FMSSG	98 MHz	60 dBμ	Mono 1 kHz 100%	Antenna Terminal	Digital Voltmeter	TP101	a	±50 mV	IF BAND: WIDE
2	Distortion	98 MHz	FMSSG	98 MHz	60 dBμ	Mono 1 kHz 100%	Antenna Terminal	Distortion Meter	Output Terminal (L)	b	Minimum Distortion	IF BAND: WIDE
3	Separation	98 MHz	FMSSG	98 MHz	60 dBμ	Stereo (L) 1 kHz 100%	Antenna Terminal	AC Voltmeter	Output Terminal (R)	VR103	Maximum Separation	IF BAND: WIDE
4	Separation	98 MHz	FMSSG	98 MHz	60 dBμ	Stereo (L) 1 kHz 100%	Antenna Terminal	AC Voltmeter	Output Terminal (R)	VR102	Maximum Separation	IF BAND: NARROW
5	Signal Level	98 MHz	FMSSG	98 MHz	20 dBμ	off	Antenna Terminal			VR101	Light TUNED on FL Display	IF BAND: WIDE

### Initializing (Memory clearing) Method

To clear memory contents of microcomputer and restore to the state of shipment at the factory, take the following step.

- While pressing the Keys 1 and 7 of the front panel, insert power cord into the AC outlet.

## FRONT END

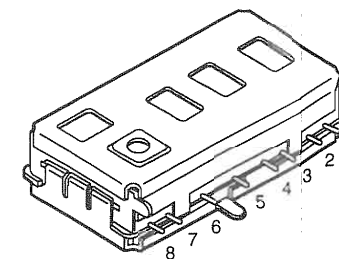
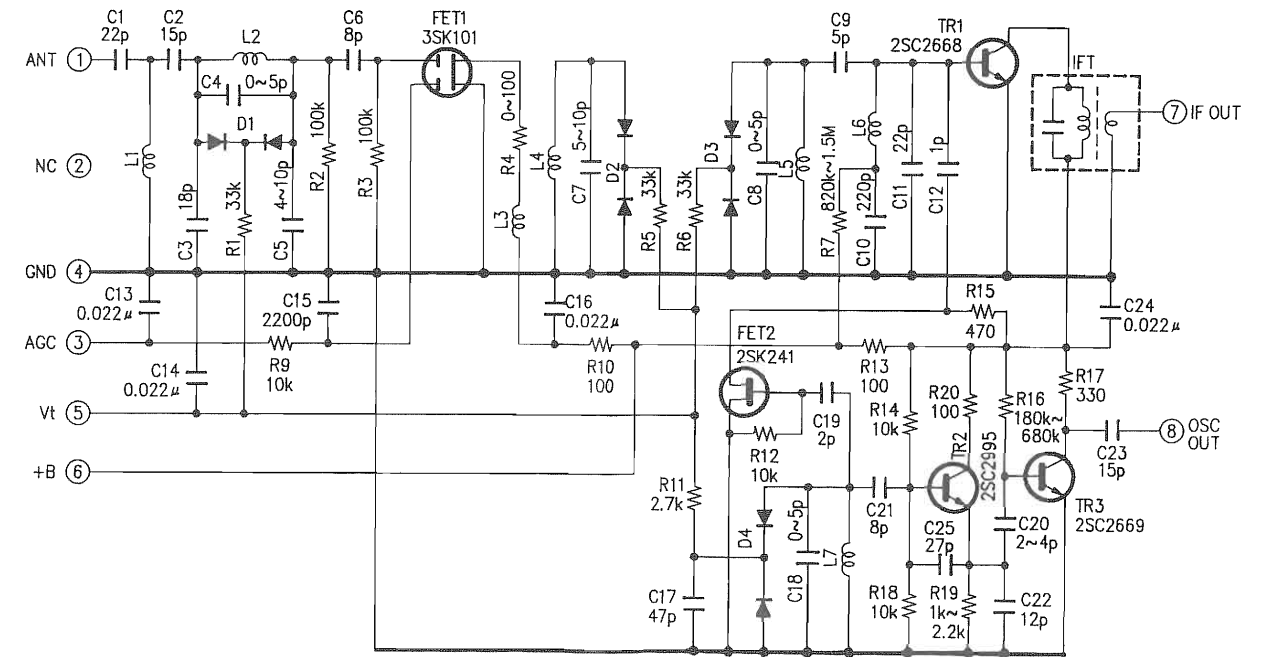

### EXTERNAL TERMINALS

1. ANT
2. NC
3. AGC
4. GND
5. Vt
6. +B
7. IF OUT
8. OSC OUT

SEMICONDUCTORS

● IC's  
TMP87CM71F-6683 (IC105)

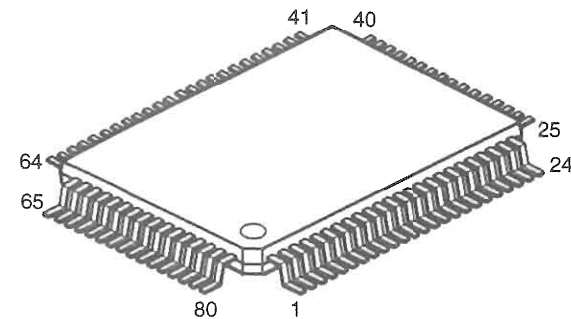

TMP87CM71F-6683 Terminal Function

Pin No.	Port Name	Symbol	I/O	Typ	Op	Det	Res	Ini	Function
1	P10/INT 0	STOP	I	—	Eu	Lv	Z	—	Power down detection
2	P11/INT 1	Not Used	I	—	Iu	—	Z	—	Connected to GND
3	P12/INT 2	RDS	I	—	Eu	S	Z	—	RDS data input (start)
4	P13/DVO	RES	O	C	Iu	—	Z	H	LC7074 reset output
5	P14	SELA	I	—	Eu	—	Z	—	Rot. Encoder input
6	P15/TC2	SELB	I	—	Eu	—	Z	—	Rot. Encoder input
7	P16	Not Used	I	—	GND	—	—	—	Connected to GND
8	P17	Not Used	I	—	GND	—	—	—	Connected to GND
9	TEST		I	—	GND	—	—	—	Connected to GND
10	P21/XTIN	TUNED	I	—	Eu	Lv	Z	—	Tuning detection (L: Tuned)
11	P22/XTO	Not Used	I	—	GND	—	Z	—	Connected to GND
12	RESET_		I	—	—	Lv	Z	—	Reset input
13	XIN		—	—	—	—	—	—	Oscillation circuit (4MHz)
14	XOUT		—	—	—	—	—	—	Oscillation circuit (4MHz)
15	Vss	GND	—	—	GND	—	—	—	Connected to GND
16	P20/INT 5	Not Used	I	—	GND	—	Z	—	Connected to GND
17	P30/INT 3	REMOTE	I	—	Eu	E&L	Z	—	Remote control signal input
18	P31/TC4	STEREO_	I	—	Eu	Lv	Z	—	When stereo receiving "L"
19	P32/SCK	RCK	I	—	Eu	S	Z	—	RDS data input (clock)
20	P33/SI	RDA	I	—	Eu	S	Z	—	RDS data input (data)
21	P34/SO	Not Used	I	—	GND	—	Z	—	Connected to GND
22	P35/HACK	CK, Not Used	I	—	GND	—	Z	—	Connected to GND
23	P36	DATA, Not Used	I	N	Eu	—	Z	H	Connected to GND
24	P37/HSO	STB	O	N	Eu	—	Z	H	LC72131/LC75711NE control output (latch)
25	P00	ANT A DATA	O	C	—	—	Z	H	LC72131/LC75711NE control output (serial data)
26	P01	ANT B CLK	O	C	—	—	Z	H	LC72131/LC75711NE control output (serial clock)
27	P02	AUTO_/MANU	O	C	—	—	Z	L	Auto/Manu control signal (L: Auto)
28	P03	RF ATT	I	—	GND	—	Z	—	L: with RF ATT, H: without RF ATT
29	P04	POWER ON/OFF	O	C	—	—	Z	H	Power relay control output (H: ON)
30	P05	WIDE	O	C	—	—	Z	—	Open
31	P06	NARROW	O	C	—	—	Z	—	Open
32	P07	RESET	O	C	—	—	Z	H	LC75711NE reset output
33	VDD	VDD	—	—	—	—	—	—	Connected to +5V
34	P60	Not Used	I	—	GND	—	Z	—	Connected to GND
35	P61	Not Used	I	—	GND	—	Z	—	Connected to GND
36	P62	Not Used	I	—	GND	—	Z	—	Connected to GND
37	P63	Not Used	I	—	GND	—	Z	—	Connected to GND
38	P64	Not Used	I	—	GND	—	Z	—	Connected to GND
39	P65	Not Used	I	—	GND	—	Z	—	Connected to GND
40	P66	Not Used	I	—	GND	—	Z	—	Connected to GND
41	P67	Not Used	I	—	GND	—	Z	—	Connect to GND
42	P70	Not Used	I	—	GND	—	Z	—	Connect to GND
43	P71	Not Used	I	—	GND	—	Z	—	Connect to GND
44	P72	Not Used	I	—	GND	—	Z	—	Connect to GND
45	P73	Not Used	I	—	GND	—	Z	—	Connect to GND
46	P74	Not Used	I	—	GND	—	Z	—	Connect to GND
47	P75	Not Used	I	—	GND	—	Z	—	Connect to GND
48	P76	Not Used	I	—	GND	—	Z	—	Connect to GND

Pin No.	Port Name	Symbol	I/O	Typ	Op	Det	Res	Ini	Function
49	P77	Not Used	I	—	GND	—	Z	—	Connect to GND
50	P80	Not Used	O	P	Iu	—	Z	—	Open
51	P81	Not Used	O	—	Iu	—	Z	—	Open
52	P82	Not Used	O	—	Iu	—	Z	—	Open
53	P83	Not Used	O	—	Iu	—	Z	—	Open
54	P84	Not Used	O	—	Iu	—	Z	—	Open
55	P85	Not Used	O	—	Iu	—	Z	—	Open
56	P66	Not Used	O	—	Iu	—	Z	—	Open
57	P87	Not Used	O	—	Iu	—	Z	—	Open
58	P90	Not Used	I	—	GND	—	Z	—	Connected to GND
59	P91	Not Used	I	—	GND	—	Z	—	Connected to GND
60	P92	Not Used	I	—	GND	—	Z	—	Connected to GND
61	P93	Not Used	I	—	GND	—	Z	—	Connected to GND
62	P94	Not Used	I	—	GND	—	Z	—	Connected to GND
63	P95	Not Used	I	—	GND	—	Z	—	Connected to GND
64	P96	Not Used	I	—	GND	—	Z	—	Connected to GND
65	P97	Not Used	I	—	GND	—	Z	—	Connected to GND
66	VKK	Not Used	—	—	GND	—	—	—	Connected to GND
67	P40/KEY0	Not Used	I	—	GND	—	Z	—	Connected to GND
68	P41/KEY1	Not Used	I	—	GND	—	Z	—	Connected to GND
69	P42/KEY2	Not Used	I	—	GND	—	Z	—	Connected to GND
70	P43/KEY3	Not Used	I	—	GND	—	Z	—	Connected to GND
71	P44/KEY4	Not Used	I	—	Eu	—	Z	—	Connected to GND
72	P45/KEY5	Not Used	I	—	Eu	—	Z	—	Connected to GND
73	P46/CIN5	KEY1	I	—	Eu	Lv	Z	—	Key input
74	P47/CIN4	KEY2	I	—	Eu	Lv	Z	—	Key input
75	P50/CIN3	KEY3	I	—	Eu	Lv	Z	—	Key input
76	P51/CIN2	KEY3	I	—	Eu	Lv	Z	—	Key input
77	P52/CIN1	VER.	I	—	Eu	Lv	Z	—	Destination setting
78	P53/CIN0	VER.	I	—	Eu	Lv	Z	—	Specifications setting
79	P54	MUTE	O	N	Eu	—	Z	H	Mute output (H: Mute)
80	P55/PMW	Not Used	I	—	GND	—	Z	—	Connected to GND

**NOTE:** Pin No. : Terminal number of microcomputer.  
 Port Name : The name entered on the data sheet of microcomputer.  
 Symbol : Symbolized interface function.  
 I/O : Input or out of port.  
     "I" = Input port  
     "O" = Output port  
 Type : Composition of port in case of output port.  
     "C" = CMOS output  
     "N" = NMOS open drain output  
     "P" = PMOS open drain output  
 OP : Pull up/Pull down selection information.  
     "Iu" = Inner microcomputer pull up  
     "Id" = Inner microcomputer pull down  
     "Eu" = External microcomputer pull up  
     "Ed" = External microcomputer pull down  
 Det : Indicates judging state of input port. Level detection is "LV"; Edge detection is "Ed"; Detection by both shifting is "E&L"; Serial data detection is "S" (Serial data output is also "S").  
 Res : State at reset.  
     "H" = Outputs High Level at reset  
     "L" = Output Low Level at reset  
     "Z" = Becomes High impedance mode at reset  
 Ini : Initial output state.  
 Function : Function and logical level explanation of signals to be interface.



PRINTED WIRING BOARD

1 2 3 4 5 6 7 8

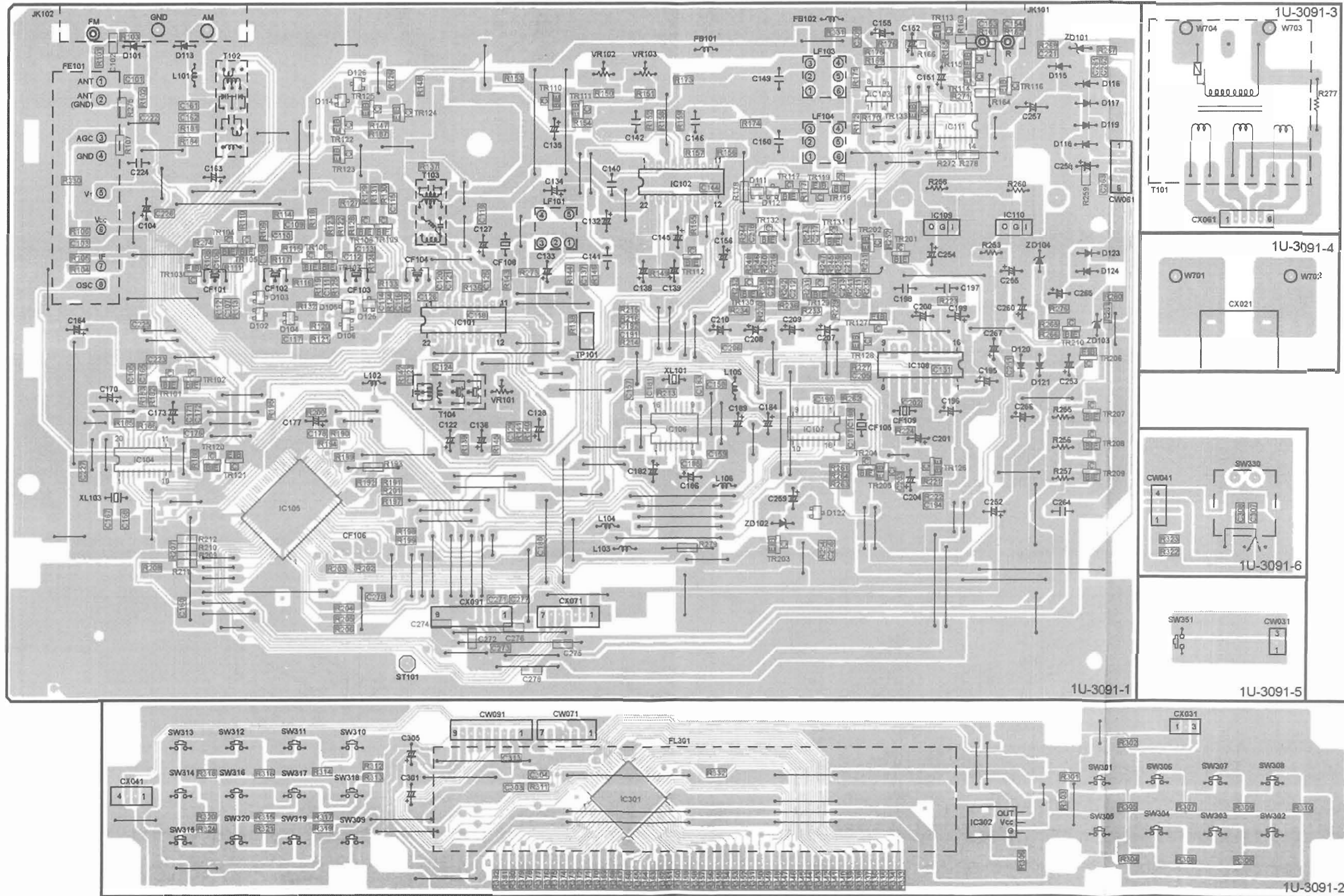

A  
B  
C  
D  
E

EXPLODED VIEW

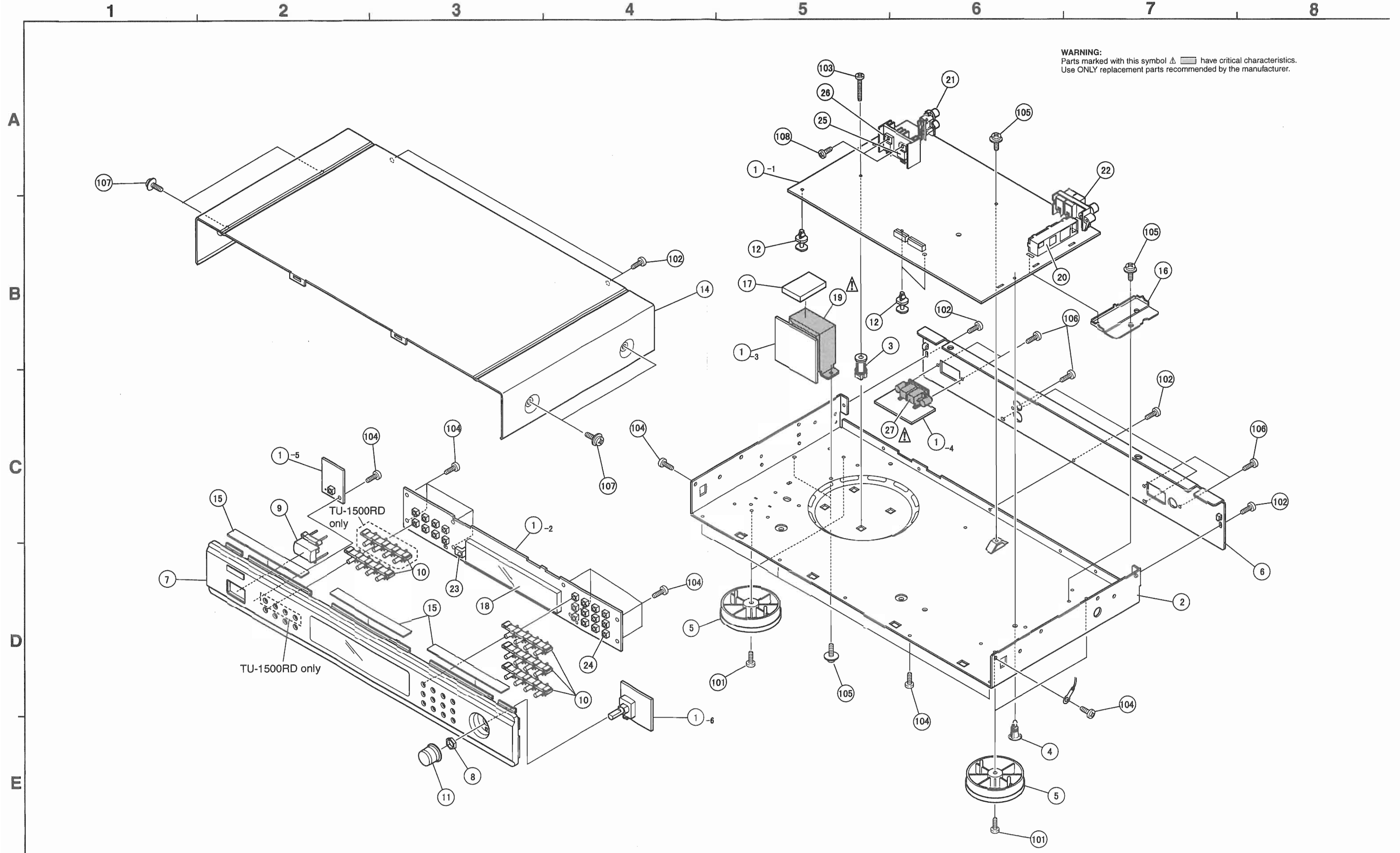



LC75711NE (IC301)

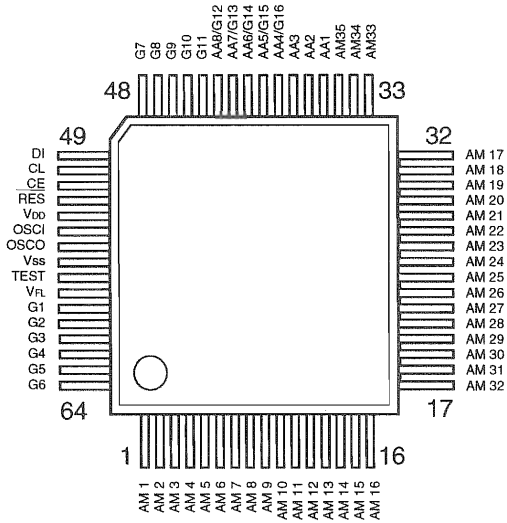

Symbol	Function
VDD	Power terminal +5V
VSS	Power terminal GND
VFL	Power terminal FL drive
DI	Serial data transfer terminal
CL	DI: Data
CE	CL: Clock
	CE: Chip enable
OSC1	External CR connecting terminal
OSCO	
RES	System reset terminal
AM1~AM35	Anode output terminal
AA1~AA3	
AA4/G16	
AA5/G15	
AA6/G14	Anode/Grid output terminal
AA7/G13	
AA8/G12	
G1~G11	
TEST	LSI test terminal

TC47HC4066AF (IC111)

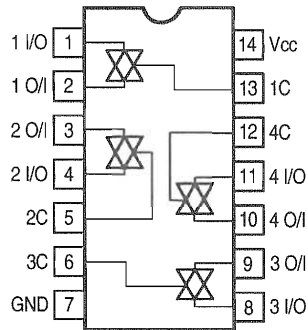
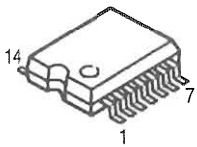

BA4558F (IC103)

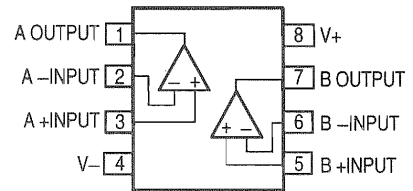
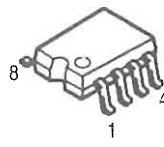

LC72131M (IC104)

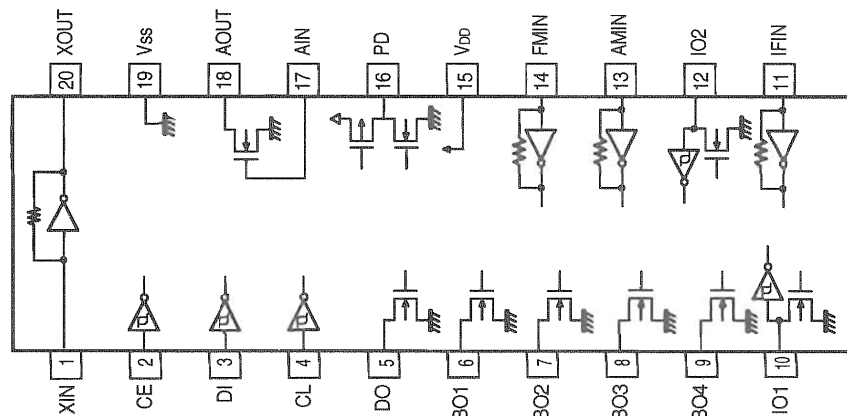
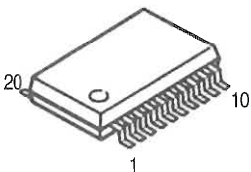

SAA6579T (IC106)

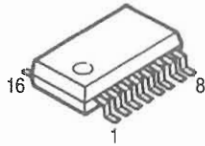

Pin No.	Symbol	Description
1	QUAL	Quality indication output.
2	RDDA	RDS data output.
3	Vref	Reference voltage output (0.5 VDDA).
4	MUX	Multiplex signal input.
5	VDDA	+5V supply voltage for analog part.
6	Vssa	Ground for analog part (0V).
7	CIN	Subcarrier input to comparator.
8	SCOUT	Subcarrier output of reconstruction filter.
9	TSTLD	Test control.
10	TEST	Test enable.
11	Vssd	Ground for digital part (0V).
12	VDDD	+5V supply voltage for digital part.
13	OSCI	Oscillator input.
14	OSCO	Oscillator output.
15	T57	57 kHz clock signal output.
16	RDCL	RDS clock output.

LC7074M (IC107)

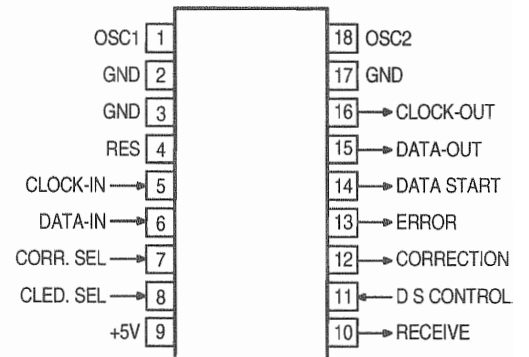
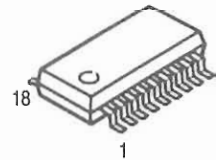

LA1265 (S) (IC101)  
LA3401 (IC102)

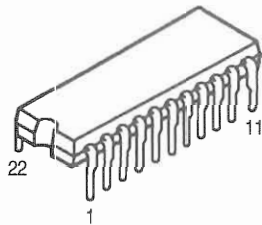

LA1265 (S)

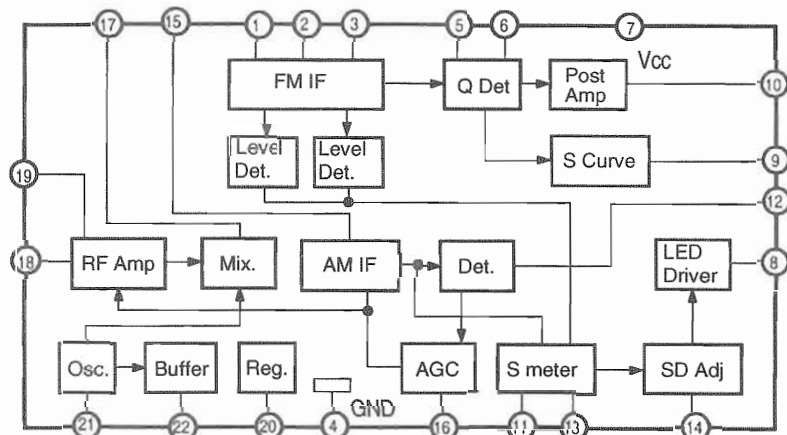

LA3401

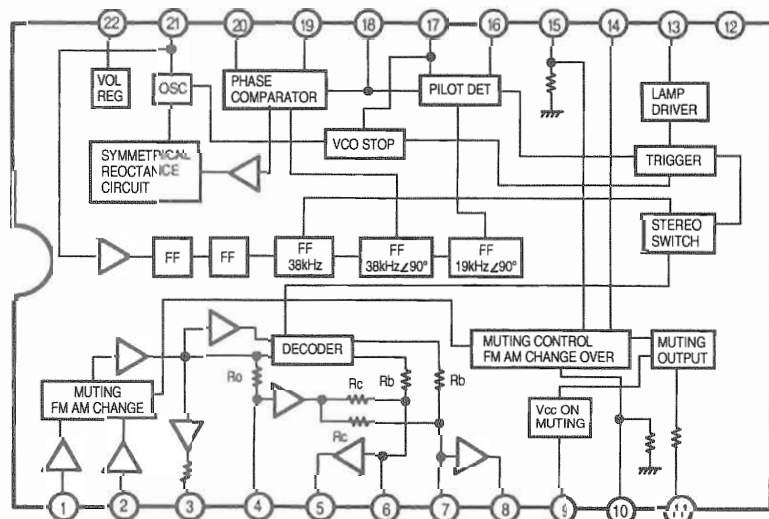

**NJM78M06FA (S) (IC110)**  
**NJM78M12FA (S) (IC109)**

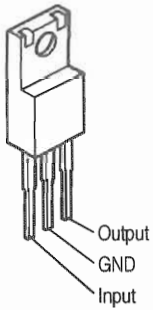

- 1: Output
- 2: GND
- 3: Input

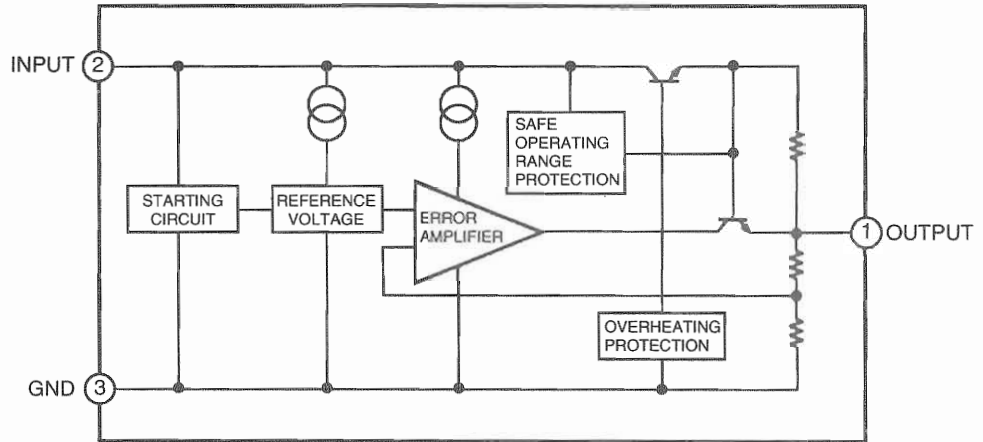

**TRANSISTORS**

**DTA114EK**  
**DTC144EK**  
**DTC323TK**

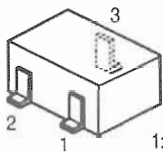

- 1: GND/Emitter
- 2: Input/Base
- 3: Output/Collector

**DTA114EK**

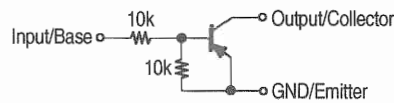

**DTC144EK**

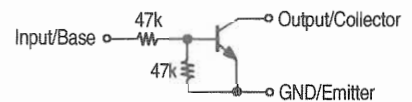

**DTC323TK**

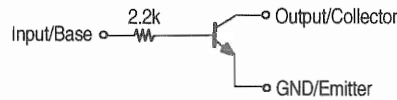

**2SK209 (Y/GR)**

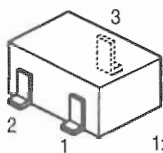

- 1: Drain
- 2: Source
- 3: Gate

**2SK211 (Y/GR)**

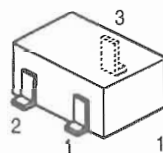

- 1: Gate
- 2: Drain
- 3: Source

**2SA1362 (Y/GR)**  
**2SC2712 (Y/GR)**  
**2SC2996 (Y)**  
**2SC3326 (A/B)**

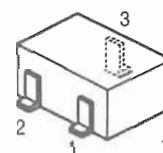

- 1: Emitter
- 2: Base
- 3: Collector

● DIODES

1SS252

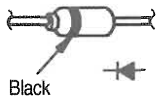

1SR35-200A

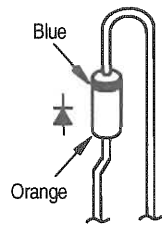

MTZJ3.3A  
MTZJ6.8C  
MTZJ8.2B  
MTZJ27D

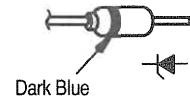

MA151A

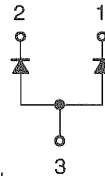
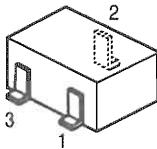

- 1: Cathode
- 2: Cathode
- 3: Anode

● REMOTE CONTROL SENSOR

GP1U271X (IC302)

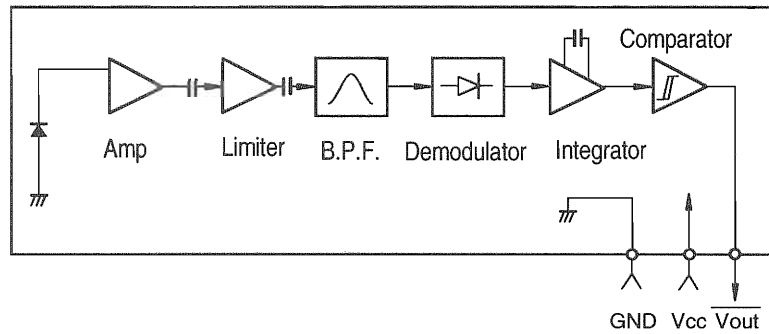
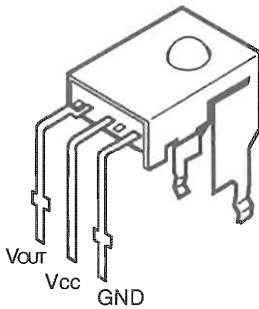

Ref. No.	Part No.	Part Name	Remarks	Ref. No.	Part No.	Part Name	Remarks
R173,174	247 0008 960	Carbon chip 3.3 kohm 1/10W	RM73B--332J	R303	247 0007 945	Carbon chip 1 kohm 1/10W	RM73B--102J
R175	247 0010 916	Carbon chip 13 kohm 1/10W	RM73B--133J	R304	247 0006 917	Carbon chip 300 ohm 1/10W	RM73B--301J
R176	247 0009 985	Carbon chip 10 kohm 1/10W	RM73B--103J	R305	247 0005 976	Carbon chip 200 ohm 1/10W	RM73B--201J
R177	247 0010 961	Carbon chip 22 kohm 1/10W	RM73B--223J	R306	247 0006 975	Carbon chip 510 ohm 1/10W	RM73B--511J
R178	247 0012 985	Carbon chip 180 kohm 1/10W	RM73B--184J	R307	247 0006 917	Carbon chip 300 ohm 1/10W	RM73B--301J
R181	247 0012 927	Carbon chip 100 kohm 1/10W	RM73B--104J	R308	247 0007 945	Carbon chip 1 kohm 1/10W	RM73B--102J
R182	247 0009 927	Carbon chip 5.6 kohm 1/10W	RM73B--562J	R309	247 0006 975	Carbon chip 510 ohm 1/10W	RM73B--511J
R183	247 0009 985	Carbon chip 10 kohm 1/10W	RM73B--103J	R310	247 0007 945	Carbon chip 1 kohm 1/10W	RM73B--102J
R184	247 0007 945	Carbon chip 1 kohm 1/10W	RM73B--102J	R312,313	247 0007 945	Carbon chip 1 kohm 1/10W	RM73B--102J
R185	247 0008 944	Carbon chip 2.7 kohm 1/10W	RM73B--272J	R314,315	247 0005 976	Carbon chip 200 ohm 1/10W	RM73B--201J
R186	247 0007 945	Carbon chip 1 kohm 1/10W	RM73B--102J	R316,317	247 0006 917	Carbon chip 300 ohm 1/10W	RM73B--301J
R187,188	247 0009 985	Carbon chip 10 kohm 1/10W	RM73B--103J	R318,319	247 0006 975	Carbon chip 510 ohm 1/10W	RM73B--511J
R189,190	247 0005 905	Carbon chip 100 ohm 1/10W	RM73B--101J	R320,321	247 0007 945	Carbon chip 1 kohm 1/10W	RM73B--102J
R191~193	247 0008 928	Carbon chip 2.2 kohm 1/10W	RM73B--222J	R322,323	247 0011 944	Carbon chip 47 kohm 1/10W	RM73B--473J
R194	247 0005 905	Carbon chip 100 ohm 1/10W	RM73B--101J	R324	247 0008 957	Carbon chip 3 kohm 1/10W	RM73B--302J
R195	247 0009 985	Carbon chip 10 kohm 1/10W	RM73B--103J	R330	247 0018 905	Carbon chip 0 ohm 1/10W	RM73B--0R0K
R197~199	247 0005 905	Carbon chip 100 ohm 1/10W	RM73B--101J	R332	247 0007 961	Carbon chip 1.2 kohm 1/10W	RM73B--122J
R200,201	247 0009 985	Carbon chip 10 kohm 1/10W	RM73B--103J	R383,384	247 0018 905	Carbon chip 0 ohm 1/10W	RM73B--0R0K
R202~206	247 0005 905	Carbon chip 100 ohm 1/10W	RM73B--101J	VR101~103	211 6093 967	Semi fixed resistor 47 kohm	V06PB473
R207	247 0009 927	Carbon chip 5.6 kohm 1/10W	RM73B--562J	<b>CAPACITORS GROUP</b>			
R208	247 0005 905	Carbon chip 100 ohm 1/10W	RM73B--101J	C101,102	257 0008 983	Ceramic chip 1000 pF/50V	CK73B1H102K
R209	247 0010 958	Carbon chip 20 kohm 1/10W	RM73B--203J	C103	257 0012 966	Ceramic chip 0.01 $\mu$ F/50V	CK73F1H103Z
R211	247 0009 985	Carbon chip 10 kohm 1/10W	RM73B--103J	C104	254 4254 909	Electrolytic 10 $\mu$ F/16V	CE04W1C100M
R212	247 0010 958	Carbon chip 20 kohm 1/10W	RM73B--203J	C105~117	257 0012 966	Ceramic chip 0.01 $\mu$ F/50V	CK73F1H103Z
R213	247 0008 928	Carbon chip 2.2 kohm 1/10W	RM73B--222J	C118	257 0011 996	Ceramic chip 0.1 $\mu$ F/25V	CK73B1E104K
R214,215	247 0009 927	Carbon chip 5.6 kohm 1/10W	RM73B--562J	C118	257 0024 909	Ceramic chip 1 $\mu$ F/16V	CK73F1C105Z
R216	247 0009 901	Carbon chip 4.7 kohm 1/10W	RM73B--472J	C119	257 0011 996	Ceramic chip 0.1 $\mu$ F/25V	CK73B1E104K
R249,250	247 0018 905	Carbon chip 0 ohm 1/10W	RM73B--0R0K	C120	257 0012 966	Ceramic chip 0.01 $\mu$ F/50V	CK73F1H103Z
R251	247 0009 927	Carbon chip 5.6 kohm 1/10W	RM73B--562J	C121	257 0012 966	Ceramic chip 0.01 $\mu$ F/50V	CK73F1H103Z
R252	247 0007 987	Carbon chip 1.5 kohm 1/10W	RM73B--152J	C122	254 4260 935	Electrolytic 0.47 $\mu$ F/50V	CE04W1HR47M
R253	244 2055 938	Metal oxide 6.8 ohm 1W	RS14B3A6R8JNBS(S)	C123	257 0004 961	Ceramic chip 100 pF/50V	CC73SL1H101J
R254	247 0013 900	Carbon chip 220 kohm 1/10W	RM73B--224J	C124	257 0012 966	Ceramic chip 0.01 $\mu$ F/50V	CK73F1H103Z
R255~256	244 2050 991	Metal oxide 6.8 kohm 1W	RS14B3A682JNBS(S)	C125	257 0009 924	Ceramic chip 2200 pF/50V	CK73B1H222K
R258	244 2055 970	Metal oxide 56 ohm 1W	RS14B3A560JNBS(S)	C126	257 0002 921	Ceramic chip 10 pF/50V	CC73SL1H100D
R260	244 2055 970	Metal oxide 56 ohm 1W	RS14B3A560JNBS(S)	C126	257 0004 961	Ceramic chip 100 pF/50V	CC73SL1H101J
R261	247 0007 945	Carbon chip 1 kohm 1/10W	RM73B--102J	C127	254 4260 922	Electrolytic 0.33 $\mu$ F/50V	CE04W1HR33M
R262	247 0009 901	Carbon chip 4.7 kohm 1/10W	RM73B--472J	C128	254 4260 948	Electrolytic 1 $\mu$ F/50V	CE04W1H010M
R263	247 0007 945	Carbon chip 1 kohm 1/10W	RM73B--102J	C129	257 0012 982	Ceramic chip 0.022 $\mu$ F/50V	CK73F1H223Z
R264	247 0009 985	Carbon chip 10 kohm 1/10W	RM73B--103J	C131	257 0012 982	Ceramic chip 0.022 $\mu$ F/50V	CK73F1H223Z
R265	247 0009 901	Carbon chip 4.7 kohm 1/10W	RM73B--472J	C132	254 4254 909	Electrolytic 10 $\mu$ F/16V	CE04W1C100M
R266	247 0007 945	Carbon chip 1 kohm 1/10W	RM73B--102J	C133,134	254 4313 921	Electrolytic 22 $\mu$ F/50V	CE04W1H220M(A5F)
R267	247 0009 985	Carbon chip 10 kohm 1/10W	RM73B--103J	C135,136	254 4254 909	Electrolytic 10 $\mu$ F/16V	CE04W1C100M
R268	247 0010 958	Carbon chip 20 kohm 1/10W	RM73B--203J	C137	257 0004 961	Ceramic chip 100 pF/50V	CC73SL1H101J
R271	247 0018 905	Carbon chip 0 ohm 1/10W	RM73B--0R0K	C138	254 4260 948	Electrolytic 1 $\mu$ F/50V	CE04W1H010M
R276	247 0011 944	Carbon chip 47 kohm 1/10W	RM73B--473J	C139	254 4260 919	Electrolytic 0.22 $\mu$ F/50V	CE04W1HR22M
R278	247 0009 985	Carbon chip 10 kohm 1/10W	RM73B--103J	C140	256 1034 937	Metallized 0.047 $\mu$ F/50V	CF93A1H473J
R279	247 0018 905	Carbon chip 0 ohm 1/10W	RM73B--0R0K	C141	256 1034 940	Metallized 0.056 $\mu$ F/50V	CF93A1H563J
R280,281	247 0005 905	Carbon chip 100 ohm 1/10W	RM73B--101J	C142	255 4237 932	Polypropylene film 510 pF/100V	CQ93P2A511J(NH)
R301	247 0007 945	Carbon chip 1 kohm 1/10W	RM73B--102J	C144	257 0012 966	Ceramic chip 0.01 $\mu$ F/50V	CK73F1H103Z
R302	247 0005 976	Carbon chip 200 ohm 1/10W	RM73B--201J	C145	254 4260 948	Electrolytic 1 $\mu$ F/50V	CF04W1H010M

Ref. No.	Part No.	Part Name	Remarks
C146	255 4237 932	Polypropylene film 510 pF/100V	CQ93P2A511J(NH)
C148	257 0012 982	Ceramic chip 0.022 μF/50V	CK73F1H223Z
C149,150	255 4232 982	Polypropylene film 2200 pF/100V	CQ93P2A222J(NH)
C151,152	254 4313 918	Electrolytic 10 μF/50V	CE04W1H100M(ASF)
C153,154	257 0009 953	Ceramic chip 3900 pF/50V	CK73B1H392K
C155	254 4492 907	Electrolytic 47 μF/25V	CE04W1E470M(ASF)
C156	254 4260 951	Electrolytic 2.2 μF/50V	CE04W1H2R2M
C157	257 0012 966	Ceramic chip 0.01 μF/50V	CK73F1H103Z
C158	257 0008 983	Ceramic chip 1000 pF/50V	CK73B1H102K
C159	257 0012 966	Ceramic chip 0.01 μF/50V	CK73F1H103Z
C160	257 0008 983	Ceramic chip 1000 pF/50V	CK73B1H102K
C161	257 0012 966	Ceramic chip 0.01 μF/50V	CK73F1H103Z
C162	257 0002 947	Ceramic chip 12 pF/50V	CC73SL1H120J
C163	254 4254 909	Electrolytic 10 μF/16V	CE04W1C100M
C164	254 4254 938	Electrolytic 47 μF/16V	CE04W1C470M
C165	257 0012 966	Ceramic chip 0.01 μF/50V	CK73F1H103Z
C167,168	257 0002 963	Ceramic chip 15 pF/50V	CC73SL1H150J
C170	254 4260 948	Electrolytic 1 μF/50V	CE04W1H010M
C171	257 0004 961	Ceramic chip 100 pF/50V	CC73SL1H101J
C172	257 0012 966	Ceramic chip 0.01 μF/50V	CK73F1H103Z
C173	254 4260 948	Electrolytic 1 μF/50V	CE04W1H010M
C174,175	257 0004 961	Ceramic chip 100 pF/50V	CC73SL1H101J
C176	257 0012 966	Ceramic chip 0.01 μF/50V	CK73F1H103Z
C177	254 4250 929	Electrolytic 100 μF/6.3V	CE04W0J101M
C178	257 0024 909	Ceramic chip 1 μF/16V	CK73F1C105Z
C180	257 0008 983	Ceramic chip 1000 pF/50V	CK73B1H102K
C181	257 0016 962	Ceramic chip 27 pF/50V	CC73CH1H270J 2125
C182	254 4260 951	Electrolytic 2.2 μF/50V	CE04W1H2R2M
C183	257 0016 962	Ceramic chip 27 pF/50V	CC73CH1H270J 2125
C184	254 4250 916	Electrolytic 47 μF/6.3V	CE04W0J470M
C185	257 0006 943	Ceramic chip 560 pF/50V	CC73SL1H561J
C186	254 4250 916	Electrolytic 47 μF/6.3V	CE04W0J470M
C187,188	257 0003 933	Ceramic chip 30 pF/50V	CC73SL1H300J
C189	254 4250 916	Electrolytic 47 μF/6.3V	CE04W0J470M
C191,192	257 0012 966	Ceramic chip 0.01 μF/50V	CK73F1H103Z
C221~223	257 0012 966	Ceramic chip 0.01 μF/50V	CK73F1H103Z
C224	256 1034 908	Metallized 0.027 μF/50V	CF93A1H273J
C225,226	257 0012 966	Ceramic chip 0.01 μF/50V	CK73F1H103Z
C251	257 0012 966	Ceramic chip 0.01 μF/50V	CK73F1H103Z
C252	259 0007 702	Back up cap. 8200 μF/5.5V	SB CAP==822=C
C253	254 4250 958	Electrolytic 470 μF/6.3V	CE04W0J471M
C254,255	254 4254 909	Electrolytic 10 μF/16V	CE04W1C100M
C256	257 0012 966	Ceramic chip 0.01 μF/50V	CK73F1H103Z
C257	254 4504 714	Electrolytic 3300 μF/35V	CE04W1V332MC(ASF)
C258	254 4260 951	Electrolytic 2.2 μF/50V	CE04W1H2R2M
C259	254 4260 977	Electrolytic 4.7 μF/50V	CE04W1H4R7M
C260	254 4258 918	Electrolytic 10 μF/35V	CE04W1V100M
C261~263	257 0012 966	Ceramic chip 0.01 μF/50V	CK73F1H103Z
C264	256 1034 979	Metallized 0.1 μF/50V	CF93A1H104J
C265	254 4261 921	Electrolytic 100 μF/50V	CE04W1H101M
C266	254 4258 950	Electrolytic 100 μF/35V	CE04W1V101M

Ref. No.	Part No.	Part Name	Remarks
C267	254 4250 958	Electrolytic 470 μF/6.3V	CE04W0J471M
C270,271	257 0008 983	Ceramic chip 1000 pF/50V	CK73B1H102K
C272	257 0004 961	Ceramic chip 100 pF/50V	CC73SL1H101J
C273	257 0008 983	Ceramic chip 1000 pF/50V	CK73B1H102K
C274,275	257 0012 966	Ceramic chip 0.01 μF/50V	CK73F1H103Z
C276~278	257 0008 983	Ceramic chip 1000 pF/50V	CK73B1H102K
C301	254 4305 968	Electrolytic 1 μF/50V	CE04W1H010M(SRE)
C303	257 0003 933	Ceramic chip 30 pF/50V	CC73SL1H300J
C304	257 0013 907	Ceramic chip 0.047 μF/50V	CK73F1H473Z
C305	254 4305 968	Electrolytic 1 μF/50V	CE04W1H010M(SRE)
C306	257 0011 996	Ceramic chip 0.1 μF/25V	CK73B1E104K
C306	257 0014 935	Ceramic chip 0.1 μF/25V	CK73F1E104Z
C307~309	257 0012 966	Ceramic chip 0.01 μF/50V	CK73F1H103Z

OTHER PARTS				Q'ty
CF101	261 0085 002	Ceramic filter SFE10.7MXH-A		1
CF102,103	261 0120 006	Ceramic filter SFE10.7MS3GK-A		2
CF104	261 0078 006	Ceramic filter SFE10.7MM(25kHz)		1
CF105	399 0041 901	Ceramic 4.0 MHz	CSA4.00MG	1
CF106	399 0191 903	Ceramic 4.0 MHz	CST4.00MGW-TF01	1
CF107	261 0079 005	Ceramic resonator CSB456F11		1
CF108	261 0031 001	Ceramic filter BFU450C4		1
CW031	203 4834 004	3P KR-DA connector cord		1
CW041	203 6374 025	4P KR-DA connector cord		1
CW061	204 0247 012	6P KR-DA connector cord		1
CW071	204 2513 074	7P KR-DA connector cord		1
CW091	204 2561 039	9P KR-DA connector cord		1
△CX021	203 2349 009	2P inlet		1
CX031	205 0343 032	3P connector base (KR-PH)		1
CX041	205 0343 045	4P connector base (KR-PH)		1
CX061	205 0343 061	6P connector base (KR-PH)		1
CX071	205 0343 074	7P connector base (KR-PH)		1
CX091	205 0343 090	9P connector base (KR-PH)		1
FB101	235 0049 900	Beads inductor		1
FB102	235 0106 908	Chip emifil (21A05)		1
FE101	216 0079 005	FM front end (U)		1
JK101	205 0274 004	2P connector base		1
JK102	205 0847 004	3P antenna terminal (PAL/F)		1
L101	235 0060 905	Inductor 2.2μH		1
L104	235 0060 950	Inductor 10μH		1
LF101	232 0159 008	Antibirdie filter		1
LF103,104	232 0148 006	MPX filter		2
SW301~320	212 5604 910	Tact switch		20

## 1U-3091D/E MAIN P.W.B. UNIT ASS'Y

Ref. No.	Part No.	Part Name	Remarks	Q'ty	Ref. No.	Part No.	Part Name	Remarks
SW330	212 0399 000	Rotary encoder		1	<b>SEMICONDUCTORS GROUP</b>			
SW351	212 5604 910	Tact switch		1	IC101	263 0891 001	IC LA1265(S)	
△ T101	233 6247 001	Power trans.		1	IC102	263 0439 007	IC LA3401	
T102	231 2096 001	MW ant.-osc. coil		1	IC103	263 0672 903	IC BA4558F	
T103	231 2102 005	FM IF Det. trans		1	IC104	262 2450 900	IC LC72131M-TLM	
T104	231 1132 005	AM IFT (SFL450J3)		1	IC105	262 2449 005	IC TMP87CM71F-****	
TP101	205 0190 036	3P NH connector base		1	IC109	263 0794 001	IC NJM78M12FA(S)	
W701	203 0598 014	1P SIN cord ass'y		1	IC110	263 0792 003	IC NJM78M06FA(S)	
W702	203 0598 001	1P SIN cord ass'y		1	IC111	262 1669 909	IC TC74HC4066AF	
XL101	399 0178 007	Crystal 4.332 MHz		1	IC301	262 2451 006	IC LC75711NE	
XL103	399 0075 003	Crystal 7.2 MHz		1	IC302	499 0290 007	Remocon sensor GP1U271X	
	203 0312 009	AMISEN ass'y		1	TR101	269 0083 901	Transistor DTA114EK	
	417 0307 008	Heat sink		1	TR102	269 0054 901	Transistor DTC144EK	
	461 0862 003	FL spacer		2	TR103	275 0074 902	FET 2SK211-Y/GR	
	471 3304 015	Screw 3x8 CBS-Z		1	TR104-109	273 0411 909	Transistor 2SC2996-Y	
					TR110,111	275 0075 901	FET 2SK209-Y/GR	
					TR112	269 0054 901	Transistor DTC144EK	
					TR113-116	269 0066 902	Transistor DTC323TK	
					TR117	269 0054 901	Transistor DTC144EK	
					TR118	269 0083 901	Transistor DTA114EK	
					TR119	269 0054 901	Transistor DTC144EK	
					TR120-122	269 0083 901	Transistor DTA114EK	
					TR123	269 0054 901	Transistor DTC144EK	
					TR124	269 0083 901	Transistor DTA114EK	
					TR125	269 0054 901	Transistor DTC144EK	
					TR133	269 0054 901	Transistor DTC144EK	
					TR201	271 0264 901	Transistor 2SA1362(Y/GR)	
					TR202-204	269 0054 901	Transistor DTC144EK	
					TR205	273 0403 904	Transistor 2SC2712-Y/GR	
					TR206	269 0083 901	Transistor DTA114EK	
					TR207-209	273 0414 906	Transistor 2SC3326(A/B)	
					TR210	271 0264 901	Transistor 2SA1362(Y/GR)	
					D101	276 0546 909	Diode 1SS110	
					D102-106	276 0438 910	Diode MA151A	
					D111,112	276 0438 910	Diode MA151A	
					D113	276 0616 907	Diode 1SS252	
					D114	276 0438 910	Diode MA151A	
					D115-121	276 0553 905	Diode 1SR35-200A	
					D122	276 0438 910	Diode MA151A	
					D123,124	276 0553 905	Diode 1SR35-200A	
					D125,126	276 0438 910	Diode MA151A	
					ZD101	276 0633 906	Zener diode MTZJ6.8C	6.8V
					ZD102	276 0634 905	Zener diode MTZJ3.3A	3.3V
					ZD103	276 0636 903	Zener diode MTZJ8.2B	8.2V
					ZD104	276 0632 907	Zener diode MTZJ27D	27V
					FL301	393 8031 009	FLD (14-BT-53GK)	

Ref. No.	Part No.	Part Name	Remarks	Ref. No.	Part No.	Part Name	Remarks
<b>RESISTORS GROUP</b>							
R101	247 0005 992	Carbon chip 240 ohm 1/10W	RM73B--241J	R171,172	247 0010 929	Carbon chip 15 kohm 1/10W	RM73B--153J
R102,103	247 0007 945	Carbon chip 1 kohm 1/10W	RM73B--102J	R173,174	247 0008 960	Carbon chip 3.3 kohm 1/10W	RM73B--332J
R104	247 0005 905	Carbon chip 100 ohm 1/10W	RM73B--101J	R175	247 0010 916	Carbon chip 13 kohm 1/10W	RM73B--133J
R105	247 0006 920	Carbon chip 330 ohm 1/10W	RM73B--331J	R176	247 0009 985	Carbon chip 10 kohm 1/10W	RM73B--103J
R106	247 0010 929	Carbon chip 15 kohm 1/10W	RM73B--153J	R177	247 0010 961	Carbon chip 22 kohm 1/10W	RM73B--223J
R107	247 0009 985	Carbon chip 10 kohm 1/10W	RM73B--103J	R178	247 0012 985	Carbon chip 180 kohm 1/10W	RM73B--184J
R108,109	247 0006 920	Carbon chip 330 ohm 1/10W	RM73B--331J	R181	247 0012 927	Carbon chip 100 kohm 1/10W	RM73B--104J
R110	247 0010 945	Carbon chip 18 kohm 1/10W	RM73B--183J	R182	247 0009 927	Carbon chip 5.6 kohm 1/10W	RM73B--562J
R111	247 0006 920	Carbon chip 330 ohm 1/10W	RM73B--331J	R183	247 0009 985	Carbon chip 10 kohm 1/10W	RM73B--103J
R112	247 0007 903	Carbon chip 680 ohm 1/10W	RM73B--681J	R184	247 0007 945	Carbon chip 1 kohm 1/10W	RM73B--102J
R113	247 0009 985	Carbon chip 10 kohm 1/10W	RM73B--103J	R185	247 0008 944	Carbon chip 2.7 kohm 1/10W	RM73B--272J
R114	247 0005 905	Carbon chip 100 ohm 1/10W	RM73B--101J	R186	247 0007 945	Carbon chip 1 kohm 1/10W	RM73B--102J
R115	247 0007 945	Carbon chip 1 kohm 1/10W	RM73B--102J	R187,188	247 0009 985	Carbon chip 10 kohm 1/10W	RM73B--103J
R116	247 0006 920	Carbon chip 330 ohm 1/10W	RM73B--331J	R189,190	247 0005 905	Carbon chip 100 ohm 1/10W	RM73B--101J
R117	247 0009 927	Carbon chip 5.6 kohm 1/10W	RM73B--562J	R191-193	247 0008 928	Carbon chip 2.2 kohm 1/10W	RM73B--222J
R118	247 0005 905	Carbon chip 100 ohm 1/10W	RM73B--101J	R194	247 0005 905	Carbon chip 100 ohm 1/10W	RM73B--101J
R119	247 0007 961	Carbon chip 1.2 kohm 1/10W	RM73B--122J	R195	247 0009 985	Carbon chip 10 kohm 1/10W	RM73B--103J
R120	247 0005 905	Carbon chip 100 ohm 1/10W	RM73B--101J	R197~199	247 0005 905	Carbon chip 100 ohm 1/10W	RM73B--101J
R121	247 0009 927	Carbon chip 5.6 kohm 1/10W	RM73B--562J	R200,201	247 0009 985	Carbon chip 10 kohm 1/10W	RM73B--103J
R122	247 0006 920	Carbon chip 330 ohm 1/10W	RM73B--331J	R202-206	247 0005 905	Carbon chip 100 ohm 1/10W	RM73B--101J
R123	247 0010 945	Carbon chip 18 kohm 1/10W	RM73B--183J	R207	247 0009 927	Carbon chip 5.6 kohm 1/10W	RM73B--562J
R124	247 0006 920	Carbon chip 330 ohm 1/10W	RM73B--331J	R208	247 0005 905	Carbon chip 100 ohm 1/10W	RM73B--101J
R125	247 0009 985	Carbon chip 10 kohm 1/10W	RM73B--103J	R209	247 0010 958	Carbon chip 20 kohm 1/10W	RM73B--203J
R126~129	247 0005 905	Carbon chip 100 ohm 1/10W	RM73B--101J	R211	247 0009 985	Carbon chip 10 kohm 1/10W	RM73B--103J
R130	247 0006 920	Carbon chip 330 ohm 1/10W	RM73B--331J	R212	247 0010 958	Carbon chip 20 kohm 1/10W	RM73B--203J
R131	247 0010 945	Carbon chip 18 kohm 1/10W	RM73B--183J	R212	247 0018 905	Carbon chip 0 ohm 1/10W	RM73B--0R0K
R132	247 0009 927	Carbon chip 5.6 kohm 1/10W	RM73B--562J	R214,215	247 0009 927	Carbon chip 5.6 kohm 1/10W	RM73B--562J
R133	247 0006 920	Carbon chip 330 ohm 1/10W	RM73B--331J	R216	247 0009 901	Carbon chip 4.7 kohm 1/10W	RM73B--472J
R134	247 0006 988	Carbon chip 560 ohm 1/10W	RM73B--561J	R227	247 0018 905	Carbon chip 0 ohm 1/10W	RM73B--0R0K
R135	247 0009 985	Carbon chip 10 kohm 1/10W	RM73B--103J	R251	247 0009 927	Carbon chip 5.6 kohm 1/10W	RM73B--562J
R136	247 0010 929	Carbon chip 15 kohm 1/10W	RM73B--153J	R252	247 0007 987	Carbon chip 1.5 kohm 1/10W	RM73B--152J
R137	247 0008 960	Carbon chip 3.3 kohm 1/10W	RM73B--332J	R253	244 2055 938	Metal oxide 6.8 ohm 1W	RS14B3A6R8JNBS(S)
R138	247 0011 902	Carbon chip 33 kohm 1/10W	RM73B--333J	R254	247 0013 900	Carbon chip 220 kohm 1/10W	RM73B--224J
R139	247 0009 985	Carbon chip 10 kohm 1/10W	RM73B--103J	R255~257	244 2050 991	Metal oxide 6.8 kohm 1W	RS14B3A682JNBS(S)
R140	247 0009 901	Carbon chip 4.7 kohm 1/10W	RM73B--472J	R258	244 2055 970	Metal oxide 56 ohm 1W	RS14B3A560JNBS(S)
R141	247 0009 927	Carbon chip 5.6 kohm 1/10W	RM73B--562J	R259	247 0012 927	Carbon chip 100 kohm 1/10W	RM73B--104J
R142	247 0011 986	Carbon chip 68 kohm 1/10W	RM73B--683J	R260	244 2055 970	Metal oxide 56 ohm 1W	RS14B3A560JNBS(S)
R143	247 0005 905	Carbon chip 100 ohm 1/10W	RM73B--101J	R261	247 0007 945	Carbon chip 1 kohm 1/10W	RM73B--102J
R144	247 0008 960	Carbon chip 3.3 kohm 1/10W	RM73B--332J	R262	247 0009 901	Carbon chip 4.7 kohm 1/10W	RM73B--472J
R145	247 0009 985	Carbon chip 10 kohm 1/10W	RM73B--103J	R263	247 0007 945	Carbon chip 1 kohm 1/10W	RM73B--102J
R146	247 0008 960	Carbon chip 3.3 kohm 1/10W	RM73B--332J	R264	247 0009 985	Carbon chip 10 kohm 1/10W	RM73B--103J
R147,148	247 0012 927	Carbon chip 100 kohm 1/10W	RM73B--104J	R265	247 0009 901	Carbon chip 4.7 kohm 1/10W	RM73B--472J
R149	247 0009 927	Carbon chip 5.6 kohm 1/10W	RM73B--562J	R266	247 0007 945	Carbon chip 1 kohm 1/10W	RM73B--102J
R150,151	247 0007 945	Carbon chip 1 kohm 1/10W	RM73B--102J	R267	247 0009 985	Carbon chip 10 kohm 1/10W	RM73B--103J
R152-155	247 0012 927	Carbon chip 100 kohm 1/10W	RM73B--104J	R268	247 0010 958	Carbon chip 20 kohm 1/10W	RM73B--203J
R156	247 0011 915	Carbon chip 36 kohm 1/10W	RM73B--363J	R271,272	247 0018 905	Carbon chip 0 ohm 1/10W	RM73B--0R0K
R157	247 0012 927	Carbon chip 100 kohm 1/10W	RM73B--104J	R275	247 0018 905	Carbon chip 0 ohm 1/10W	RM73B--0R0K
R158,159	247 0012 998	Carbon chip 200 kohm 1/10W	RM73B--204J	R276	247 0011 944	Carbon chip 47 kohm 1/10W	RM73B--473J
R161,162	247 0012 927	Carbon chip 100 kohm 1/10W	RM73B--104J	R278	247 0009 985	Carbon chip 10 kohm 1/10W	RM73B--103J
R163~166	247 0004 906	Carbon chip 39 ohm 1/10W	RM73B--390J	R280,281	247 0005 905	Carbon chip 100 ohm 1/10W	RM73B--101J
R169,170	247 0010 974	Carbon chip 24 kohm 1/10W	RM73B--243J				



Ref. No.	Part No.	Part Name	Remarks	Ref. No.	Part No.	Part Name	Remarks
R301	247 0007 945	Carbon chip 1 kohm 1/10W	RM73B--102J	C148	257 0012 982	Ceramic chip 0.022 $\mu$ F/50V	CK73F1H223Z
R302	247 0005 976	Carbon chip 200 ohm 1/10W	RM73B--201J	C149,150	255 4232 982	Polypropylene film 2200 pF/100V	CQ93P2A222J(NH)
R303	247 0007 945	Carbon chip 1 kohm 1/10W	RM73B--102J	C151,152	254 4313 918	Electrolytic 10 $\mu$ F/50V	CE04W1H100M(ASF)
R304	247 0006 917	Carbon chip 300 ohm 1/10W	RM73B--301J	C153,154	257 0009 953	Ceramic chip 3900 pF/50V	CK73B1H392K
R305	247 0005 976	Carbon chip 200 ohm 1/10W	RM73B--201J	C155	254 4492 907	Electrolytic 47 $\mu$ F/25V	CE04W1E470M(ASF)
R306	247 0006 975	Carbon chip 510 ohm 1/10W	RM73B--511J	C156	254 4260 951	Electrolytic 2.2 $\mu$ F/50V	CE04W1H2R2M
R307	247 0006 917	Carbon chip 300 ohm 1/10W	RM73B--301J	C157	257 0012 966	Ceramic chip 0.01 $\mu$ F/50V	CK73F1H103Z
R308	247 0007 945	Carbon chip 1 kohm 1/10W	RM73B--102J	C158	257 0008 983	Ceramic chip 1000 pF/50V	CK73B1H102K
R309	247 0006 975	Carbon chip 510 ohm 1/10W	RM73B--511J	C159	257 0012 966	Ceramic chip 0.01 $\mu$ F/50V	CK73F1H103Z
R310	247 0007 945	Carbon chip 1 kohm 1/10W	RM73B--102J	C161	257 0012 966	Ceramic chip 0.01 $\mu$ F/50V	CK73F1H103Z4
R312,313	247 0007 945	Carbon chip 1 kohm 1/10W	RM73B--102J	C162	257 0002 947	Ceramic chip 12 pF/50V	CC73SL1H120J
R314,315	247 0005 976	Carbon chip 200 ohm 1/10W	RM73B--201J	C163	254 4254 909	Electrolytic 10 $\mu$ F/16V	CE04W1C100M
R316,317	247 0006 917	Carbon chip 300 ohm 1/10W	RM73B--301J	C164	254 4254 938	Electrolytic 47 $\mu$ F/16V	CE04W1C470M
R318,319	247 0006 975	Carbon chip 510 ohm 1/10W	RM73B--511J	C165	257 0012 966	Ceramic chip 0.01 $\mu$ F/50V	CK73F1H103Z
R320,321	247 0007 945	Carbon chip 1 kohm 1/10W	RM73B--102J	C167,168	257 0002 963	Ceramic chip 15 pF/50V	CC73SL1H150J
R322,323	247 0011 944	Carbon chip 47 kohm 1/10W	RM73B--473J	C170	254 4260 948	Electrolytic 1 $\mu$ F/50V	CE04W1H010M
R324	247 0008 957	Carbon chip 3 kohm 1/10W	RM73B--302J	C171	257 0004 961	Ceramic chip 100 pF/50V	CC73SL1H101J
R330	247 0018 905	Carbon chip 0 ohm 1/10W	RM73B--0R0K	C172	257 0012 966	Ceramic chip 0.01 $\mu$ F/50V	CK73F1H103Z
R332	247 0007 961	Carbon chip 1.2 kohm 1/10W	RM73B--122J	C173	254 4260 948	Electrolytic 1 $\mu$ F/50V	CE04W1H010M
R383,384	247 0018 905	Carbon chip 0 ohm 1/10W	RM73B--0R0K	C176	257 0012 966	Ceramic chip 0.01 $\mu$ F/50V	CK73F1H103Z
VR101~103	211 6093 967	Semi fixed resistor 47 kohm	V06PB473	C177	254 4250 929	Electrolytic 100 $\mu$ F/6.3V	CE04W0J101M
<b>CAPACITORS GROUP</b>				C178	257 0024 909	Ceramic chip 1 $\mu$ F/16V	CK73F1C105Z
C101,102	257 0008 983	Ceramic chip 1000 pF/50V	CK73B1H102K	C180	257 0008 983	Ceramic chip 1000 pF/50V	CK73B1H102K
C103	257 0012 966	Ceramic chip 0.01 $\mu$ F/50V	CK73F1H103Z	C191,192	257 0012 966	Ceramic chip 0.01 $\mu$ F/50V	CK73F1H103Z
C104	254 4254 909	Electrolytic 10 $\mu$ F/16V	CE04W1C100M	C221~223	257 0012 966	Ceramic chip 0.01 $\mu$ F/50V	CK73F1H103Z
C105~117	257 0012 966	Ceramic chip 0.01 $\mu$ F/50V	CK73F1H103Z	C224	256 1034 908	Metallized 0.027 $\mu$ F/50V	CF93A1H273J
C118	257 0011 996	Ceramic chip 0.1 $\mu$ F/25V	CK73B1E104K	C225,226	257 0012 966	Ceramic chip 0.01 $\mu$ F/50V	CK73F1H103Z
C118	257 0024 909	Ceramic chip 1 $\mu$ F/16V	CK73F1C105Z	C251	257 0012 966	Ceramic chip 0.01 $\mu$ F/50V	CK73F1H103Z
C119	257 0011 996	Ceramic chip 0.1 $\mu$ F/25V	CK73B1E104K	C252	259 0007 702	Back up cap. 8200 $\mu$ F/5.5V	SB CAP==822=C
C120,121	257 0012 966	Ceramic chip 0.01 $\mu$ F/50V	CK73F1H103Z	C253	254 4250 958	Electrolytic 470 $\mu$ F/6.3V	CE04W0J471M
C121	257 0012 966	Ceramic chip 0.01 $\mu$ F/50V	CK73F1H103Z	C254,255	254 4254 909	Electrolytic 10 $\mu$ F/16V	CE04W1C100M
C122	254 4260 935	Electrolytic 0.47 $\mu$ F/50V	CE04W1HR47M	C256	257 0012 966	Ceramic chip 0.01 $\mu$ F/50V	CK73F1H103Z
C123	257 0004 961	Ceramic chip 100 pF/50V	CC73SL1H101J	C257	254 4504 714	Electrolytic 3300 $\mu$ F/35V	CE04W1V332MC(ASF)
C124	257 0012 966	Ceramic chip 0.01 $\mu$ F/50V	CK73F1H103Z	C258	254 4260 948	Electrolytic 1 $\mu$ F/50V	CE04W1H010M
C125	257 0009 924	Ceramic chip 2200 pF/50V	CK73B1H222K	C259	254 4260 977	Electrolytic 4.7 $\mu$ F/50V	CE04W1H4R7M
C126	257 0004 961	Ceramic chip 100 pF/50V	CC73SL1H101J	C260	254 4258 918	Electrolytic 10 $\mu$ F/35V	CE04W1V100M
C127	254 4260 922	Electrolytic 0.33 $\mu$ F/50V	CE04W1HR33M	C261~263	257 0012 966	Ceramic chip 0.01 $\mu$ F/50V	CK73F1H103Z
C128	254 4260 948	Electrolytic 1 $\mu$ F/50V	CE04W1H010M	C264	256 1034 979	Metallized 0.1 $\mu$ F/50V	CF93A1H104J
C129	257 0012 982	Ceramic chip 0.022 $\mu$ F/50V	CK73F1H223Z	C265	254 4261 921	Electrolytic 100 $\mu$ F/50V	CE04W1H101M
C131	257 0012 982	Ceramic chip 0.022 $\mu$ F/50V	CK73F1H223Z	C266	254 4258 950	Electrolytic 100 $\mu$ F/35V	CE04W1V101M
C132	254 4254 909	Electrolytic 10 $\mu$ F/16V	CE04W1C100M	C267	254 4250 958	Electrolytic 470 $\mu$ F/6.3V	CE04W0J471M
C135,136	254 4254 909	Electrolytic 10 $\mu$ F/16V	CE04W1C100M	C301	254 4305 968	Electrolytic 1 $\mu$ F/50V	CE04W1H010M(SRE)
C138	254 4260 948	Electrolytic 1 $\mu$ F/50V	CE04W1H010M	C303	257 0003 933	Ceramic chip 30 pF/50V	CC73SL1H300J
C139	254 4260 919	Electrolytic 0.22 $\mu$ F/50V	CE04W1HR22M	C304	257 0014 935	Ceramic chip 0.1 $\mu$ F/25V	CK73F1E104Z
C140	256 1034 937	Metallized 0.047 $\mu$ F/50V	CF93A1H473J	C305	254 4305 968	Electrolytic 1 $\mu$ F/50V	CE04W1H010M(SRE)
C141	256 1034 940	Metallized 0.056 $\mu$ F/50V	CF93A1H563J	C306	257 0011 996	Ceramic chip 0.1 $\mu$ F/25V	CK73B1E104K
C142	255 4237 932	Polypropylene film 510 pF/100V	CQ93P2A511J(NH)	C306	257 0014 935	Ceramic chip 0.1 $\mu$ F/25V	CK73F1E104Z
C144	257 0012 966	Ceramic chip 0.01 $\mu$ F/50V	CK73F1H103Z	C307~309	257 0012 966	Ceramic chip 0.01 $\mu$ F/50V	CK73F1H103Z
C145	254 4260 948	Electrolytic 1 $\mu$ F/50V	CE04W1H010M				
C146	255 4237 932	Polypropylene film 510 pF/100V	CQ93P2A511J(NH)				

Ref. No.	Part No.	Part Name	Remarks	Q'ty	Ref. No.	Part No.	Part Name	Remarks	Q'ty
<b>OTHER PARTS</b>									
CF101	261 0085 002	Ceramic filter SFE10.7MXH-A		1		203 0312 009	AMISEN ass'y		1
CF102,103	261 0120 006	Ceramic filter SFE10.7MS3GK-A		2		417 0307 008	Heat sink		1
CF104	261 0078 006	Ceramic filter SFE10.7MM(25kHz)		1		461 0862 003	FL spacer		2
CF106	399 0191 903	Ceramic resonator CST4.00MGW		1		471 3304 015	Screw 3x8 CBS-Z		1
CF107	261 0079 005	Ceramic resonator CSB456F11		1					
CF108	261 0031 001	Ceramic filter BFU450C4		1					
CW031	203 4834 004	3P KR-DA connector cord		1					
CW041	203 6374 025	4P KR-DA connector cord		1					
CW061	204 0247 012	6P KR-DA connector cord		1					
CW071	204 2513 074	7P KR-DA connector cord		1					
CW091	204 2561 039	9P KR-DA connector cord		1					
△CX021	203 2349 009	2P inlet		1					
CX031	205 0343 032	3P connector base (KR-PH)		1					
CX041	205 0343 045	4P connector base (KR-PH)		1					
CX061	205 0343 061	6P connector base (KR-PH)		1					
CX071	205 0343 074	7P connector base (KR-PH)		1					
CX091	205 0343 090	9P connector base (KR-PH)		1					
FB101	235 0049 900	Beads inductor		1					
FB102	235 0106 908	Chip emfil (21A05)		1					
FE101	216 0079 005	FM front end (U)		1					
JK101	205 0274 004	2P connector base		1					
JK102	205 0847 004	3P antenna terminal (PAL/F)		1					
L101	235 0060 905	Inductor 2.2μH		1					
L104	235 0060 950	Inductor 10μH		1					
LF101	232 0159 008	Antibirdie filter		1					
LF103,104	232 0148 006	MPX filter		2					
SW301-320	212 5604 910	Tact switch		20					
SW330	212 0399 000	Rotary encorder		1					
SW351	212 5604 910	Tact switch		1					
△T101	233 6247 001	Power trans.	Asia model	1					
△T101	233 6250 001	Power trans.	Taiwan R.O.C model	1					
T102	231 2096 001	MW ant.-osc. coil		1					
T103	231 2102 005	FM IF Det. trans		1					
T104	231 1132 005	AM IFT (SFL450J3)		1					
TP101	205 0190 036	3P NH connector base		1					
W701	203 0598 014	1P SIN cord Ass'y		1					
W702	203 0598 001	1P SIN cord Ass'y		1					
XL103	399 0075 003	Crystal 7.2 MHz		1					

● FL DISPLAY 14-BT-53GK (FLT701)  
(Part No.: DCD2150423)

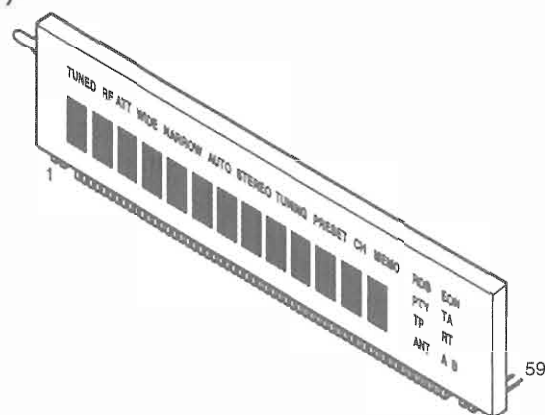

Pin Connection

PIN No.	1	2	3	4	5	6	7	8	9	0	1	1	1	1	1	1	1	1	2	2	2	2	2	2	2	2	2	2	3	
Connection	F	F	N	N		1	2	3	4	5	6	7	8	9	0	1	2	3	4	3	3	3	3	3	3	2	2	2	2	3
	1	1	P	P	G	G	G	G	G	G	G	G	G	G	G	G	G	G	6	5	4	3	2	1	0	9	8	7	6	5

PIN No.	3	3	3	3	3	3	3	3	4	4	4	4	4	4	4	4	4	4	5	5	5	5	5	5	5	5	5	5	5		
Connection	P	P	P	P	P	P	P	P	P	P	P	P	P	P	P	P	P	P	P	P	P	N	N	N	F	F	F	F	F		
	2	2	2	2	2	1	1	1	1	1	1	1	1	1	1	1	1	1	8	7	6	5	4	3	2	1	C	P	P	2	2
	4	3	2	1	0	9	8	7	6	5	4	3	2	0	9	8	7	6	5	4	3	2	1	C	P	P	2	2			

Note: F : Filament  
 NP : No pin  
 NC : No connection  
 G : Grid  
 P : Amode

Grid Assignment

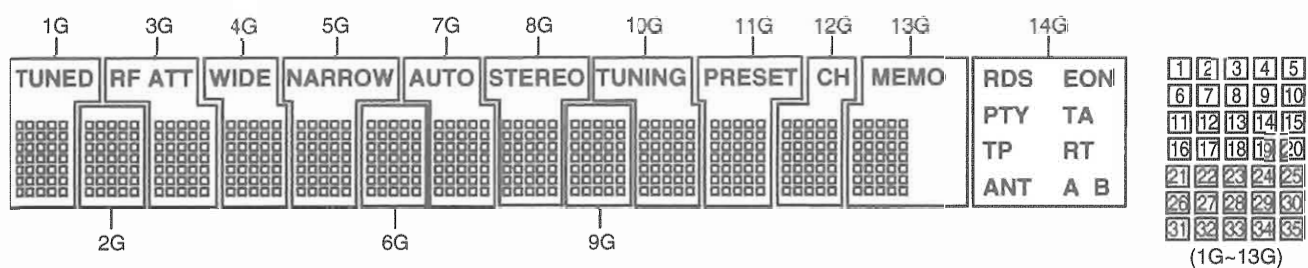

Anode Connection

	P1	P2	P3	P4	P5	P6	P7	P8	P9	P10	P11	P12	P13	P14	P15	P16	P17	P18
1~13G	1	2	3	4	5	6	7	8	9	10	11	12	13	14	15	16	17	18

	P19	P20	P21	P22	P23	P24	P25	P26	P27	P28	P29	P30	P31	P32	P33	P34	P35
1~13G	19	20	21	22	23	24	25	26	27	28	29	30	31	32	33	34	35

	P1	P2	P3	P4	P5	P6	P7	P8
14G	PTY	TP	ANT	EON	TA	RT	A	B

  

	1G	2G	3G	4G	5G	6G	7G	8G
P36	TUNED	—	RF ATT	WIDE	NARROW	—	AUTO	STEREO

	9G	10G	11G	12G	13G	14G
P36	—	TUNING	PRESET	CH	MEMO	RDS

### NOTE FOR PARTS LIST

- Part indicated with the mark "⊙" are not always in stock and possibly to take a long period of time for supplying, or in some case supplying of part may be refused.
  - When ordering of part, clearly indicate "1" and "1" (1) to avoid mis-supplying.
  - Ordering part without stating its part number can not be supplied.
  - Part indicated with the mark "★" is not illustrated in the exploded view.
  - Not including Carbon Film ±5%, 1/4W Type in the P.W.Board parts list. (Refer to the Schematic Diagram for those parts.)
- WARNING:**  
Parts marked with this symbol  have critical characteristics.  
Use ONLY replacement parts recommended by the manufacturer.

#### ● Resistors

Ex.: **RN** **14K** **2E** **182** **G** **FR**  
 Type Shape Power Resist- Allowable Others  
 and per- ance error

RD : Carbon	2B : 1/8W	F : ±1%	P : Pulse-resistant type
RC : Composition	2E : 1/4W	G : ±2%	NL : Low noise type
RS : Metal oxide film	2H : 1/2W	J : ±5%	NB : Non-burning type
RW : Winding	3A : 1W	K : ±10%	FR : Fuse-resistor
RN : Metal film	3D : 2W	M : ±20%	F : Lead wire forming
RK : Metal mixture	3F : 3W		
	3H : 5W		

#### \* Resistance

$\overset{1}{\text{R}}\overset{2}{\text{R}} \Rightarrow 1800 \text{ ohm} = 1.8 \text{ kohm}$   
 Indicates number of zeros after effective number.  
 2-digit effective number.  
 • Units: ohm

$\overset{1}{\text{R}}\overset{2}{\text{R}} \Rightarrow 1.2 \text{ ohm}$   
 1-digit effective number.  
 2-digit effective number, decimal point indicated by R.  
 • Units: ohm

#### ● Capacitors

Ex.: **CE** **04W** **1H** **2R2** **M** **BP**  
 Type Shape Dielectric Capacity Allowable Others  
 and per- strength error

CE : Aluminum foil electrolytic	0J : 6.3V	F : ±1%	HS : High stability type
CA : Aluminum solid electrolytic	1A : 10V	G : ±2%	BP : Non-polar type
CS : Tantalum electrolytic	1C : 16V	J : ±5%	HR : Ripple-resistant type
CO : Film	1E : 25V	K : ±10%	DL : For charge and discharge
CK : Ceramic	1V : 35V	M : ±20%	HF : For assuring high frequency
CC : Ceramic	1H : 50V	Z : +80%	U : UL part
CP : Oil	2A : 100V	-20%	C : CSA part
CM : Mica	2B : 125V	P : +100%	W : UL-CSA type
CF : Metallized	2C : 160V	-0%	F : Lead wire forming
CH : Metallized	2D : 200V	C : ±0.25pF	
	2E : 250V	D : ±0.5pF	
	2H : 500V	= : Others	
	2J : 630V		

#### \* Capacity (electrolyte only)

$\overset{2}{\text{R}}\overset{2}{\text{R}} \Rightarrow 2200\mu\text{F}$   
 Indicates number of zeros after effective number.  
 2-digit effective number.  
 • Units: μF.

$\overset{2}{\text{R}}\overset{2}{\text{R}} \Rightarrow 2.2\mu\text{F}$   
 1-digit effective number.  
 2-digit effective number, decimal point indicated by R.  
 • Units: μF.

#### \* Capacity (except electrolyte)

$\overset{2}{\text{R}}\overset{2}{\text{R}} \Rightarrow 2200\text{pF} = 0.0022\mu\text{F}$   
 (More than 2) — Indicates number of zeros after effective number.  
 2-digit effective number.  
 • Units: μF.

$\overset{2}{\text{R}}\overset{1}{\text{R}} \Rightarrow 220\text{pF}$   
 (0 or 1) — Indicates number of zeros after effective number.  
 2-digit effective number.  
 • Units: pF.

• When the dielectric strength is indicated in AC, "AC" is included after the dielectric strength value.

### PARTS LIST OF P.W.B. UNIT ASS'Y 1U-3091B MAIN P.W.B. UNIT ASS'Y

Ref. No.	Part No.	Part Name	Remarks	Ref. No.	Part No.	Part Name	Remarks
<b>SEMICONDUCTORS GROUP</b>				<b>RESISTORS GROUP</b>			
IC101	263 0891 001	IC LA1265(S)		R101	247 0005 992	Carbon chip 240 ohm 1/10W	RM73B--241J
IC102	263 0439 007	IC LA3401		R102,103	247 0007 945	Carbon chip 1 kohm 1/10W	RM73B--102J
IC103	263 0672 903	IC BA4558F		R104	247 0005 905	Carbon chip 100 ohm 1/10W	RM73B--101J
IC104	262 2450 900	IC LC72131M-TLM		R105	247 0006 920	Carbon chip 330 ohm 1/10W	RM73B--331J
IC105	262 2449 005	IC TMP87CM71F-****		R106	247 0010 929	Carbon chip 15 kohm 1/10W	RM73B--153J
IC106	262 1701 906	IC SAA6579T		R107	247 0009 985	Carbon chip 10 kohm 1/10W	RM73B--103J
IC107	262 1929 908	IC LC7074M-TE-R		R108,109	247 0006 920	Carbon chip 330 ohm 1/10W	RM73B--331J
IC109	263 0794 001	IC NJM78M12FA(S)		R110	247 0010 945	Carbon chip 18 kohm 1/10W	RM73B--183J
IC110	263 0792 003	IC NJM78M06FA(S)		R111	247 0006 920	Carbon chip 330 ohm 1/10W	RM73B--331J
IC111	262 1669 909	IC TC74HC4066AF		R112	247 0007 903	Carbon chip 680 ohm 1/10W	RM73B--681J
				R113	247 0009 985	Carbon chip 10 kohm 1/10W	RM73B--103J
IC301	262 2451 006	IC LC75711NE		R114	247 0005 905	Carbon chip 100 ohm 1/10W	RM73B--101J
IC302	499 0290 007	Remocon sensor GP1U271X		R115	247 0007 945	Carbon chip 1 kohm 1/10W	RM73B--102J
TR101	269 0083 901	Transistor DTA114EK		R116	247 0006 920	Carbon chip 330 ohm 1/10W	RM73B--331J
TR102	269 0054 901	Transistor DTC144EK		R117	247 0009 927	Carbon chip 5.6 kohm 1/10W	RM73B--562J
TR103	275 0074 902	FET 2SK211-Y/GR		R118	247 0005 905	Carbon chip 100 ohm 1/10W	RM73B--101J
TR104~109	273 0411 909	Transistor 2SC2996-Y		R119	247 0007 961	Carbon chip 1.2 kohm 1/10W	RM73B--122J
TR110,111	275 0075 901	FET 2SK209-Y/GR		R120	247 0005 905	Carbon chip 100 ohm 1/10W	RM73B--101J
TR112	269 0054 901	Transistor DTC144EK		R121	247 0009 927	Carbon chip 5.6 kohm 1/10W	RM73B--562J
TR113~116	269 0066 902	Transistor DTC323TK		R122	247 0006 920	Carbon chip 330 ohm 1/10W	RM73B--331J
TR117	269 0054 901	Transistor DTC144EK		R123	247 0010 945	Carbon chip 18 kohm 1/10W	RM73B--183J
TR118	269 0083 901	Transistor DTA114EK		R124	247 0006 920	Carbon chip 330 ohm 1/10W	RM73B--331J
TR119	269 0054 901	Transistor DTC144EK		R125	247 0009 985	Carbon chip 10 kohm 1/10W	RM73B--103J
TR120~122	269 0083 901	Transistor DTA114EK		R126~129	247 0005 905	Carbon chip 100 ohm 1/10W	RM73B--101J
TR123	269 0054 901	Transistor DTC144EK		R130	247 0006 920	Carbon chip 330 ohm 1/10W	RM73B--331J
TR124	269 0083 901	Transistor DTA114EK		R131	247 0010 945	Carbon chip 18 kohm 1/10W	RM73B--183J
TR125	269 0054 901	Transistor DTC144EK		R132	247 0009 927	Carbon chip 5.6 kohm 1/10W	RM73B--562J
TR133	269 0054 901	Transistor DTC144EK		R133	247 0006 920	Carbon chip 330 ohm 1/10W	RM73B--331J
				R134	247 0006 988	Carbon chip 560 ohm 1/10W	RM73B--561J
TR201	271 0264 901	Transistor 2SA1362(Y/GR)		R135	247 0009 985	Carbon chip 10 kohm 1/10W	RM73B--103J
TR202~204	269 0054 901	Transistor DTC144EK		R136	247 0010 929	Carbon chip 15 kohm 1/10W	RM73B--153J
TR205	273 0403 904	Transistor 2SC2712-Y/GR		R137	247 0008 960	Carbon chip 3.3 kohm 1/10W	RM73B--332J
TR206	269 0083 901	Transistor DTA114EK		R138	247 0011 902	Carbon chip 33 kohm 1/10W	RM73B--333J
TR207~209	273 0414 906	Transistor 2SC3326(A/B)		R139	247 0009 985	Carbon chip 10 kohm 1/10W	RM73B--103J
TR210	271 0264 901	Transistor 2SA1362(Y/GR)		R140	247 0009 901	Carbon chip 4.7 kohm 1/10W	RM73B--472J
				R141	247 0009 927	Carbon chip 5.6 kohm 1/10W	RM73B--562J
D101	276 0546 909	Diode 1SS110		R142	247 0011 986	Carbon chip 68 kohm 1/10W	RM73B--683J
D102~106	276 0438 910	Diode MA151A		R143	247 0005 905	Carbon chip 100 ohm 1/10W	RM73B--101J
D111,112	276 0438 910	Diode MA151A		R144	247 0008 960	Carbon chip 3.3 kohm 1/10W	RM73B--332J
D113	276 0616 907	Diode 1SS252		R145	247 0009 985	Carbon chip 10 kohm 1/10W	RM73B--103J
D114	276 0438 910	Diode MA151A		R146	247 0008 960	Carbon chip 3.3 kohm 1/10W	RM73B--332J
D115~121	276 0553 905	Diode 1SR35-200A		R147,148	247 0012 927	Carbon chip 100 kohm 1/10W	RM73B--104J
D122	276 0438 910	Diode MA151A		R149	247 0009 927	Carbon chip 5.6 kohm 1/10W	RM73B--562J
D123,124	276 0553 905	Diode 1SR35-200A		R150,151	247 0007 945	Carbon chip 1 kohm 1/10W	RM73B--102J
D125,126	276 0438 910	Diode MA151A		R152-155	247 0012 927	Carbon chip 100 kohm 1/10W	RM73B--104J
ZD101	276 0644 966	Zener diode MTZJ12A	12V	R156	247 0011 915	Carbon chip 36 kohm 1/10W	RM73B--363J
ZD102	276 0634 905	Zener diode MTZJ3.3A	3.3V	R157	247 0012 927	Carbon chip 100 kohm 1/10W	RM73B--104J
ZD103	276 0636 903	Zener diode MTZJ8.2B	8.2V	R158,159	247 0012 998	Carbon chip 200 kohm 1/10W	RM73B--204J
ZD104	276 0632 907	Zener diode MTZJ27D	27V	R163~166	247 0004 906	Carbon chip 39 ohm 1/10W	RM73B--390J
FL301	393 8031 009	FLD (14-BT-53GK)		R169,170	247 0010 974	Carbon chip 24 kohm 1/10W	RM73B--243J
				R171,172	247 0010 929	Carbon chip 15 kohm 1/10W	RM73B--153J

## PARTS LIST OF EXPLODED VIEW

Ref. No.	Part No.	Part Name	Remarks	Q'ty	Ref. No.	Part No.	Part Name	Remarks	Q'ty
1	See next page	Main P.W.B. unit ass'y		1	105	473 8007 025	Cup screw 3 x 8		4
1-1	See next page	Tuner unit			106	477 0064 107	Fixing screw		5
1-2	See next page	Display unit			107	477 0263 005	3P. swelling screw	Black model	4
1-3	See next page	Power trans. unit				477 0263 018	3P. swelling screw	Gold model	4
1-4	See next page	Inlet unit			108	471 3304 015	Screw 3 x 8 CBS-Z		2
1-5	See next page	Power switch unit							
1-6	See next page	Rotary encoder unit							
2	411 0942 902	Chassis		1	<b>PACKING &amp; ACCESSORIES</b>				
3	412 2762 002	P.W.B. holder	H=12	1	201	505 0283 018	Poly. cover		1
4	412 2741 007	P.W.B. holder (H=8)	H=8	1	202	See next page	Instruction manual		1
5	104 0208 308	Foot ass'y		4	△ 203	See next page	AC cord with plug		1
6	See next page	Rear panel		1	204	399 0350 003	Remote controller RC-824	Europe & U.K. model only	1
7	See next page	Front panel ass'y		1	205	515 0671 627	Service station list (EX)		1
8	—	9 nut		1	206	203 2310 009	2P pin cord		1
9	113 1292 207	Push button (P)	Black model	1	207	231 0922 009	Loop antenna		1
	113 1292 210	Push button (P)	Gold model	1	208	395 0023 008	FM antenna ass'y		1
10	113 1838 111	Tact button	Black model	5	209	505 0131 050	Cabinet cover		1
	113 1838 108	Tact button	Gold model	5	210	See next page	Cushion		2
	113 1838 108	Tact button	TU-1500 only	4	211	See next page	Carton case		1
11	112 0813 011	Tunning knob	Black model	1	212	See next page	POS label		1
	112 0813 008	Tunning knob	Gold model	1	213	513 1389 006	Control card base		1
12	412 2814 002	Card spacer (L=8)		3	214	513 1349 004	Thermal carbon film		1
13	445 8004 007	Wire clasper		1	215	502 0898 022	Pad	U.K. model only	2
14	102 0592 102	Top cover	Gold model	1	216	513 3155 018	KOLIN label (T)	Taiwan R.O.C model only	1
	102 0592 115	Top cover	Black model	1					
15	461 0577 000	Rubber sheet		3	217	513 9111 001	Color label (gold)	Gold model only	1
16	414 0839 001	Shield cover		1					
17	461 0551 026	Rubber sheet		1					
18	393 8031 009	FLD (14-BT-53GK)	FL301	1					
△ 19	See next page	Power trans.	T101	1					
20	216 0079 005	FM front end (U)	FE101	1					
21	205 0274 004	2P connector base	JK101	1					
22	205 0847 004	3P antenna terminal (PAL/F)	JK102	1					
23	499 0290 007	Remocon sensor GP1U271X	IC302	1					
24	212 5604 910	Tact switch		21					
25	263 0794 001	iC NJM78M12FA(S)	IC109	1					
26	263 0792 003	iC NJM78M06FA(S)	IC110	1					
△ 27	203 2349 009	2P inlet	CX021	1					
28	513 1642 002	No. sheet		1					
29	513 2769 023	Rating sheet (T)	Taiwan R.O.C model only	1					
30	513 2481 000	Serial no. sheet (T)	Taiwan R.O.C model only	1					
31	513 2482 009	Caution label (T)	Taiwan R.O.C model only	1					
32	414 0839 001	Shield cover		1					
<b>SCREWS</b>									
101	473 7002 018	Screw 3 x 8 CBTS(S)-Z		4					
102	473 7015 018	Screw 3 x 8 CBTS(S)-B		7					
103	473 7501 030	Screw 3 x 20 CBTS (P)-Z		1					
104	473 7508 017	Screw 3 x 10 CBTS(P)-B		15					

## ADDEMDUM PARTS LIST OF EXPLODED VIEW

Ref. No.	Part Name	TU-1500RD			TU-1500		Remarks
		Part No.			Part No.		
		Europe model		U.K. model	Asia model	Taiwan R.O.C model	
		Gold model	Black model	Black model	Gold model	Gold model	
1	Main P.W.B. unit ass'y	1U-3091B	1U-3091B	1U-3091B	1U-3091D	1U-3091E	
1-1	Tuner unit	1U-3091B-1	1U-3091B-1	1U-3091B-1	1U-3091D-1	1U-3091E-1	
1-2	Display unit	1U-3091B-2	1U-3091B-2	1U-3091B-2	1U-3091D-2	1U-3091E-2	
1-3	Power trans. unit	1U-3091B-3	1U-3091B-3	1U-3091B-3	1U-3091D-3	1U-3091E-3	
1-4	Inlet unit	1U-3091B-4	1U-3091B-4	1U-3091B-4	1U-3091D-4	1U-3091E-4	
1-5	Power switch unit	1U-3091B-5	1U-3091B-5	1U-3091B-5	1U-3091D-5	1U-3091E-5	
1-6	Rotary encoder unit	1U-3091B-6	1U-3091B-6	1U-3091B-6	1U-3091D-6	1U-3091E-6	
6	Rear panel	105 1271 104	105 1271 104	105 1271 104	105 1271 120	105 1271 133	
7	Front panel ass'y	144 2593 103	144 2593 116	144 2593 116	144 2593 145	144 2593 145	
△ 19	Power trans.	233 6247 001	233 6247 001	233 6247 001	233 6247 001	233 6250 001	
202	Instruction manual	511 3238 007	511 3238 007	511 3238 007	511 3241 007	511 3241 007	
△ 203	AC cord with plug	206 2108 003	206 2108 003	206 2113 001	206 2108 003	206 2142 001	
210	Cushion	503 1284 007	503 1284 007	503 1284 007	503 1280 108	503 1280 108	
211	Carton case	501 2000 006	501 2000 006	501 2000 035	501 2000 048	501 2000 048	
212	POS label	517 1356 015	517 1356 028	517 1338 075			

**SCHEMATIC DIAGRAM (1/2)**

1 2 3 4 5 6 7 8

A

B

C

D

E

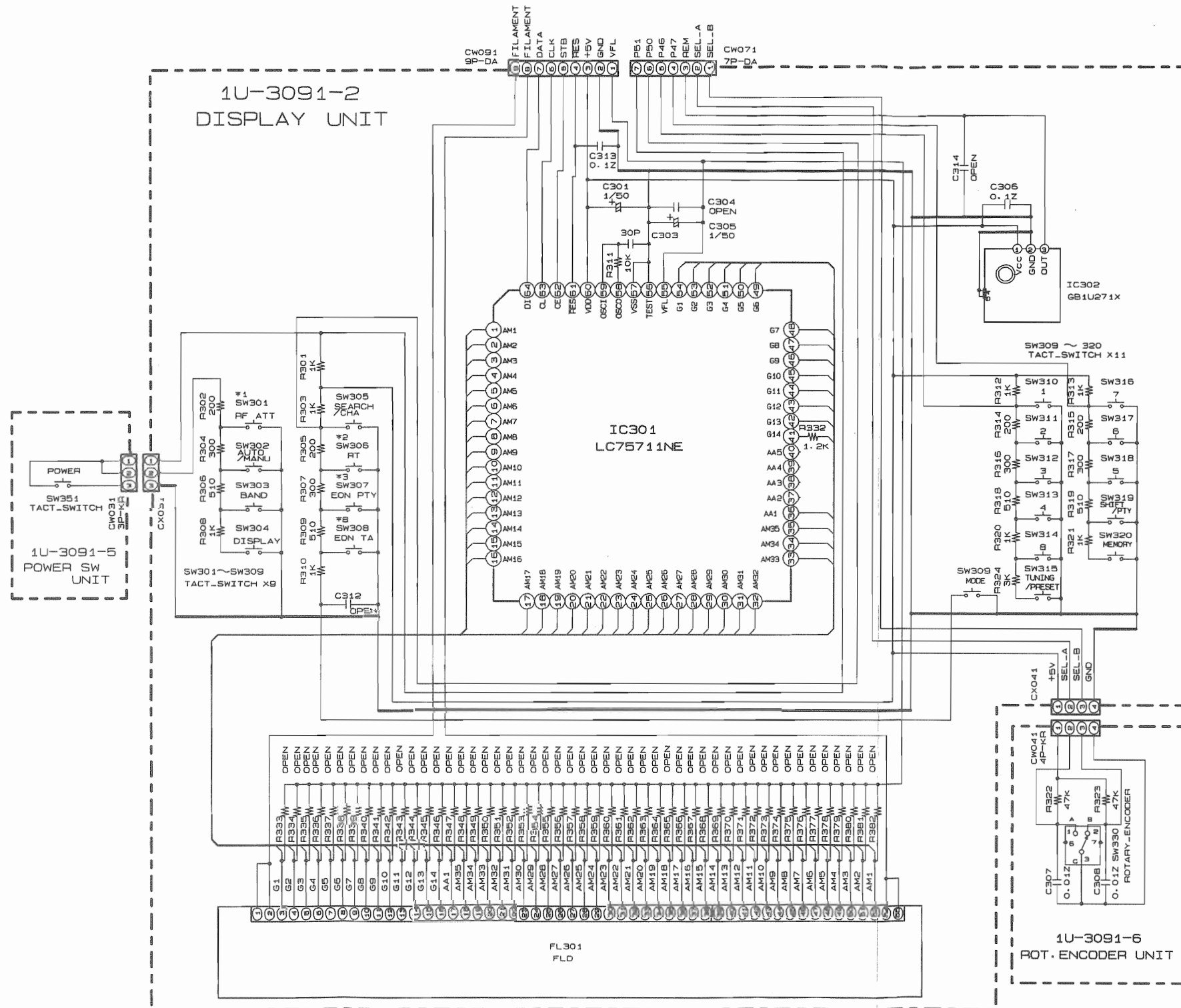

Part Version	*1 SW301	*2 SW306	*3 SW307	*4 SW308
JAPAN	X	X	X	X
E2/EK	O	O	O	O
E1	X	X	X	X
E1T	X	X	X	X
E3	X	X	X	X

**NOTICE**

ALL RESISTANCE VALUES IN OHM. k=1,000 OHM M=1,000,000 OHM  
 ALL CAPACITANCE VALUES IN MICRO FARAD. P=MICRO-MICRO FARAD  
 EACH VOLTAGE AND CURRENT ARE MEASURED AT NO SIGNAL INPUT CONDITION.  
 CIRCUIT AND PARTS ARE SUBJECT TO CHANGE WITHOUT PRIOR NOTICE.

**WARNING:**

Parts marked with this symbol have critical characteristics. Use ONLY replacement parts recommended by the manufacturer.

**CAUTION:**

Before returning the unit to the customer, make sure you make either (1) a leakage current check or (2) a line to chassis resistance check. If the leakage current exceeds 0.5 milliamps, or if the resistance from chassis to either side of the power cord is less than 240 kohms, the unit is defective.

**WARNING:**

DO NOT return the unit to the customer unit the problem is located and corrected.

BLOCK DIAGRAM

1 2 3 4 5 6 7 8

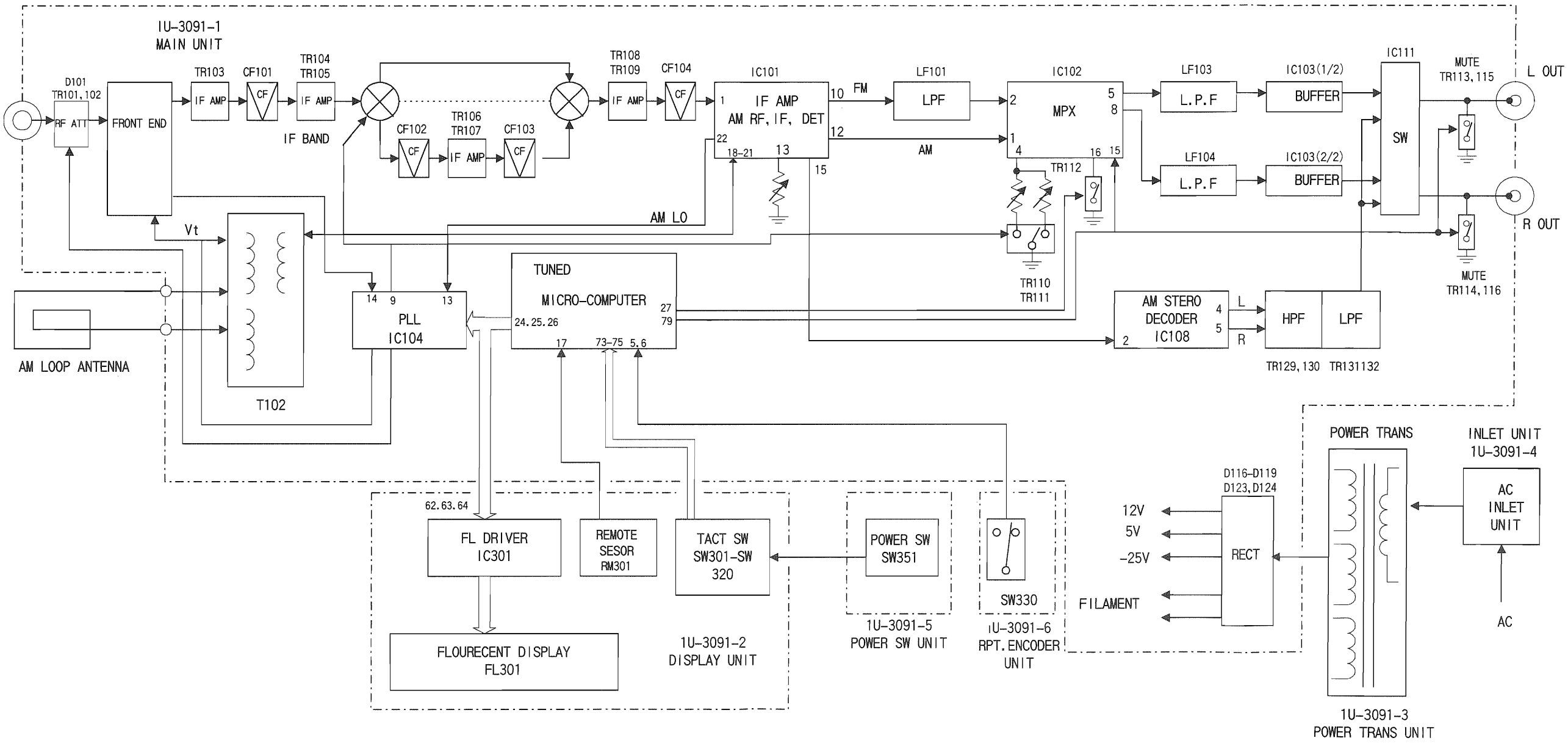

A  
B  
C  
D  
E



## DISASSEMBLY

(Follow the procedure below in reverse order when reassembling)

### Top Cover

1. Remove 6 screws ① fixing the Top Cover.  
(4 on both sides, 2 on the rear)
2. Detach the Top Cover, moving backwards a little and lifting it as shown in the arrow direction.

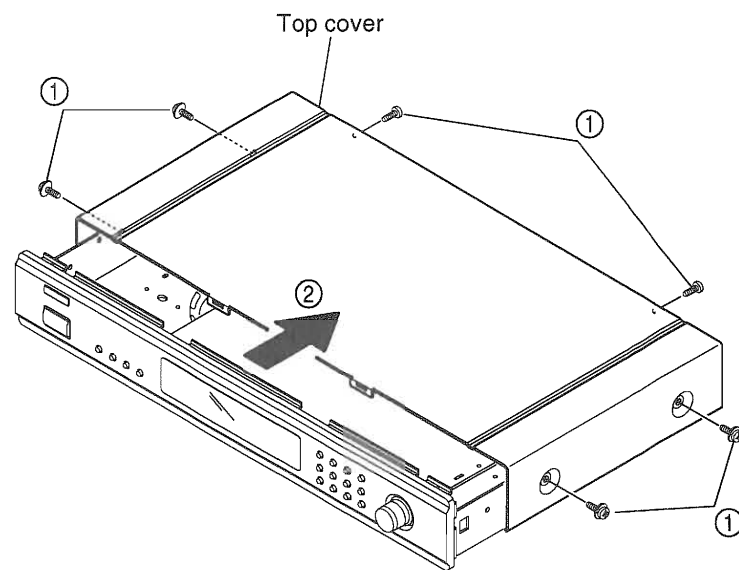

### Tuner P.W.B.

1. Remove 3 screws ③ fixing the Tuner P.W.B.
2. Remove 3 screws ④ on the rear.
3. Disconnect 3 connectors ⑤.
4. Release the Tuner P.W.B. from P.W.B. holder ⑥.

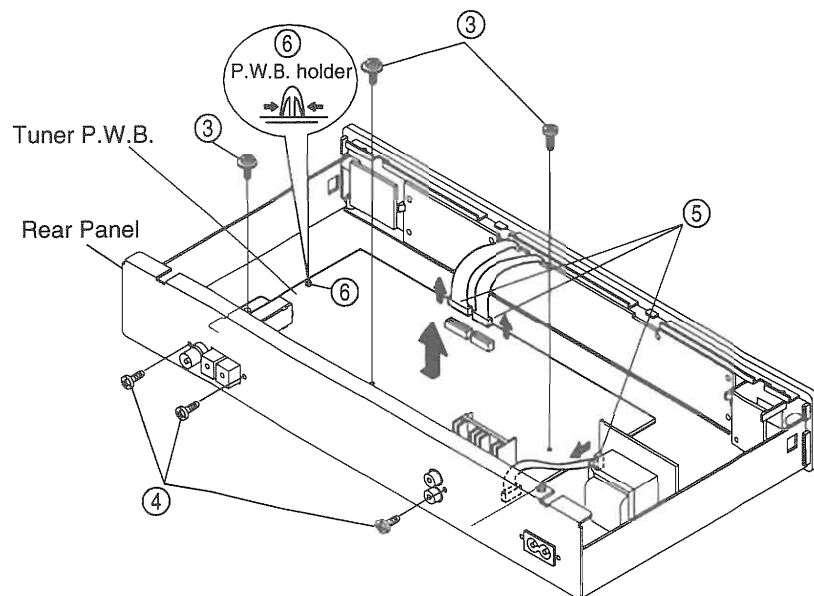

### Front Panel

1. Remove 6 screws ⑧ fixing the Front Panel.  
(2 on both sides, 4 on the bottom)

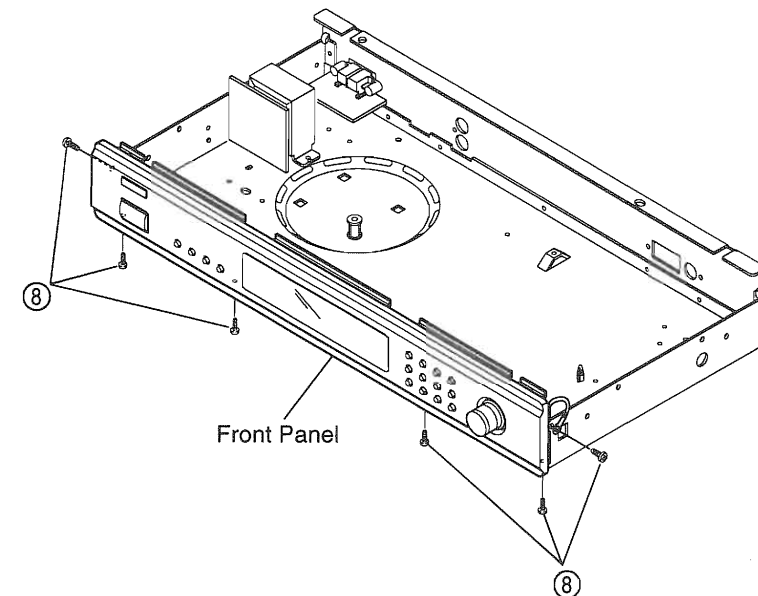

2. Remove 9 screws ⑨ fixing each P.W.B.
3. Detach the 1U-3091-2 P.W.B. from the Front Panel as shown in the arrow by releasing 2 hooks ⑩.
4. Detach the 1U-3091-5 and 1U-3091-6 P.W.B.s from the Front Panel as shown in the arrow, after pulling out tuning knob ⑪ and removing nut ⑫.

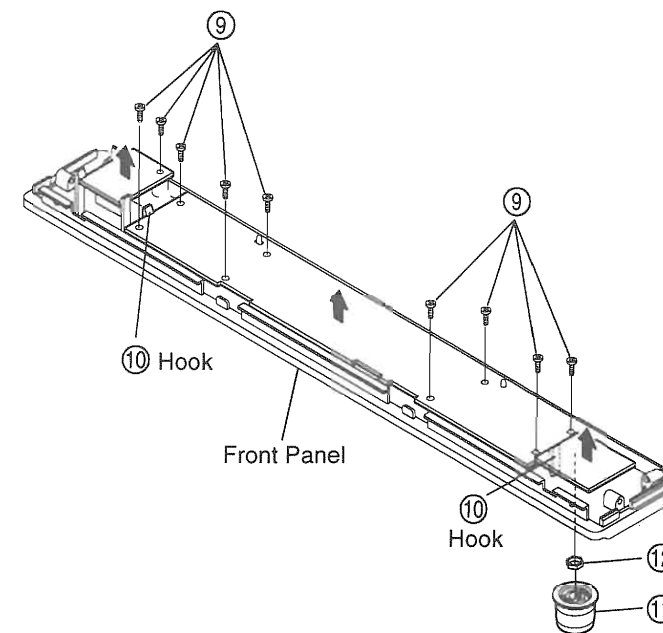



SCHEMATIC DIAGRAM (2/2)

1 2 3 4 5 6

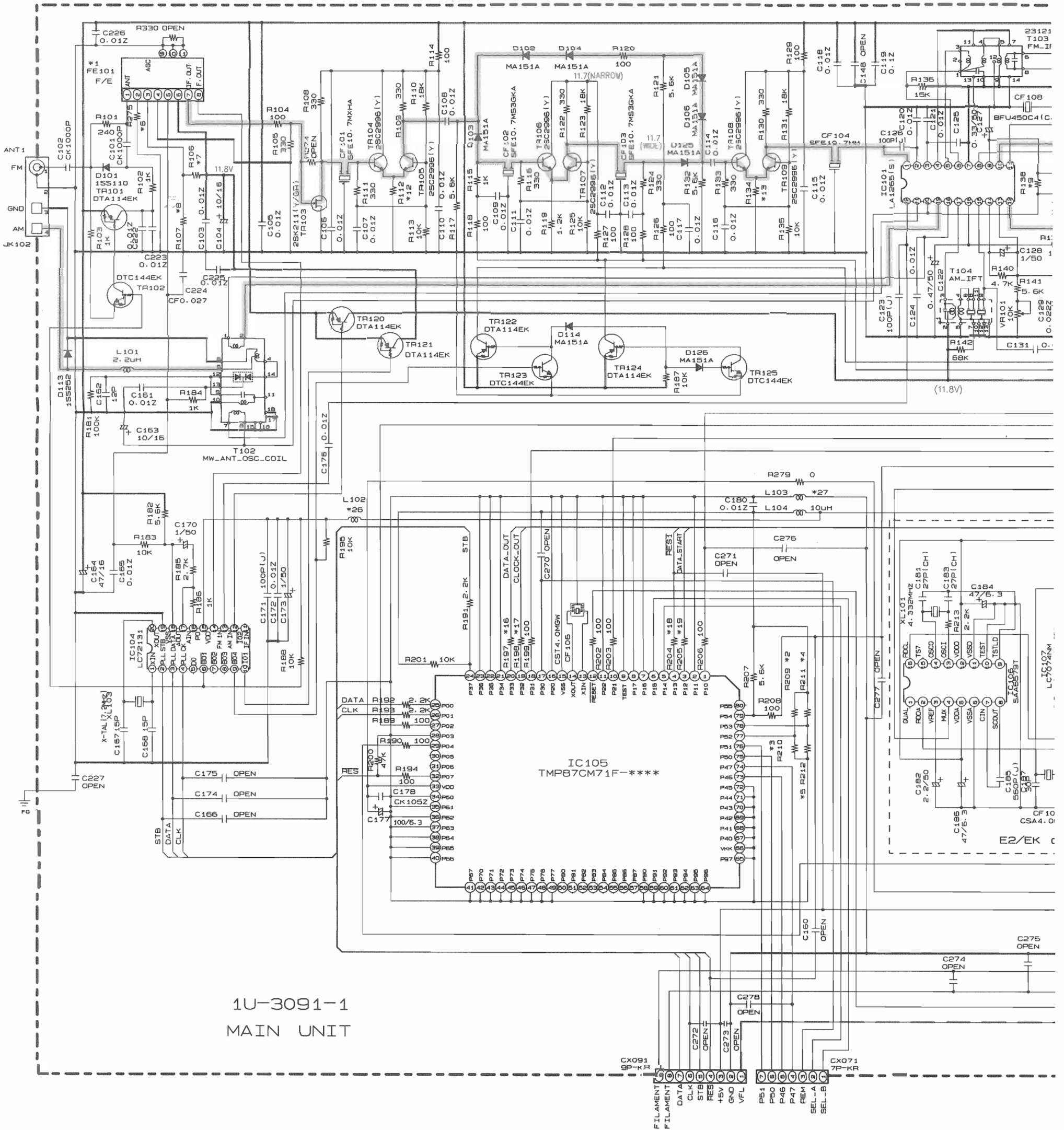

1U-3091-1  
MAIN UNIT

Part #1	*2	*3	*4	*5	*6	*7	*8	*9	*10	*11	*12	*13	*14	*15	*16	*17	*18	*19	*20	*21	*22	*23	*24	*25	*26	*27	*28	
Version	FE101	R209	R210	R211	R212	R275	R106	R107	R138	R169	R170	R112	R134	R271	R272	R197	R198	R204	R205	R277	R331	C137	C141	C142	C146	L102	L103	FB
JAPAN	2619012005	20K	3.9K	10K	20K	---	---	---	18K	13K	13K	1.8K	1.2K	---	---	---	---	---	---	---	0	---	---	510P	510P	10uH	10uH	---
E2	2160079005	20K	---	10K	---	0	15K	10K	33K	24K	24K	680	560	0	0	100	100	100	100	---	---	100P	0.056	510P	510P	JUMPER	JUMPER	YI
EK	2160079005	20K	---	10K	---	0	15K	10K	33K	24K	24K	680	560	0	0	100	100	100	100	---	---	100P	0.056	510P	510P	JUMPER	JUMPER	YI
E1	2160079005	20K	---	10K	20K	0	15K	10K	33K	24K	24K	680	560	0	0	---	---	---	---	---	---	---	0.056	510P	510P	JUMPER	JUMPER	---
E1T	2160079005	20K	---	10K	20K	0	15K	10K	33K	24K	24K	680	560	0	0	---	---	---	---	---	---	---	0.056	510P	510P	JUMPER	JUMPER	---
E3	2160079005	---	3.9K	10K	---	0	15K	10K	18K	13K	13K	680	560	0	0	---	---	---	---	---	---	---	0.056	750P	750P	JUMPER	JUMPER	---

7

8

9

10

11

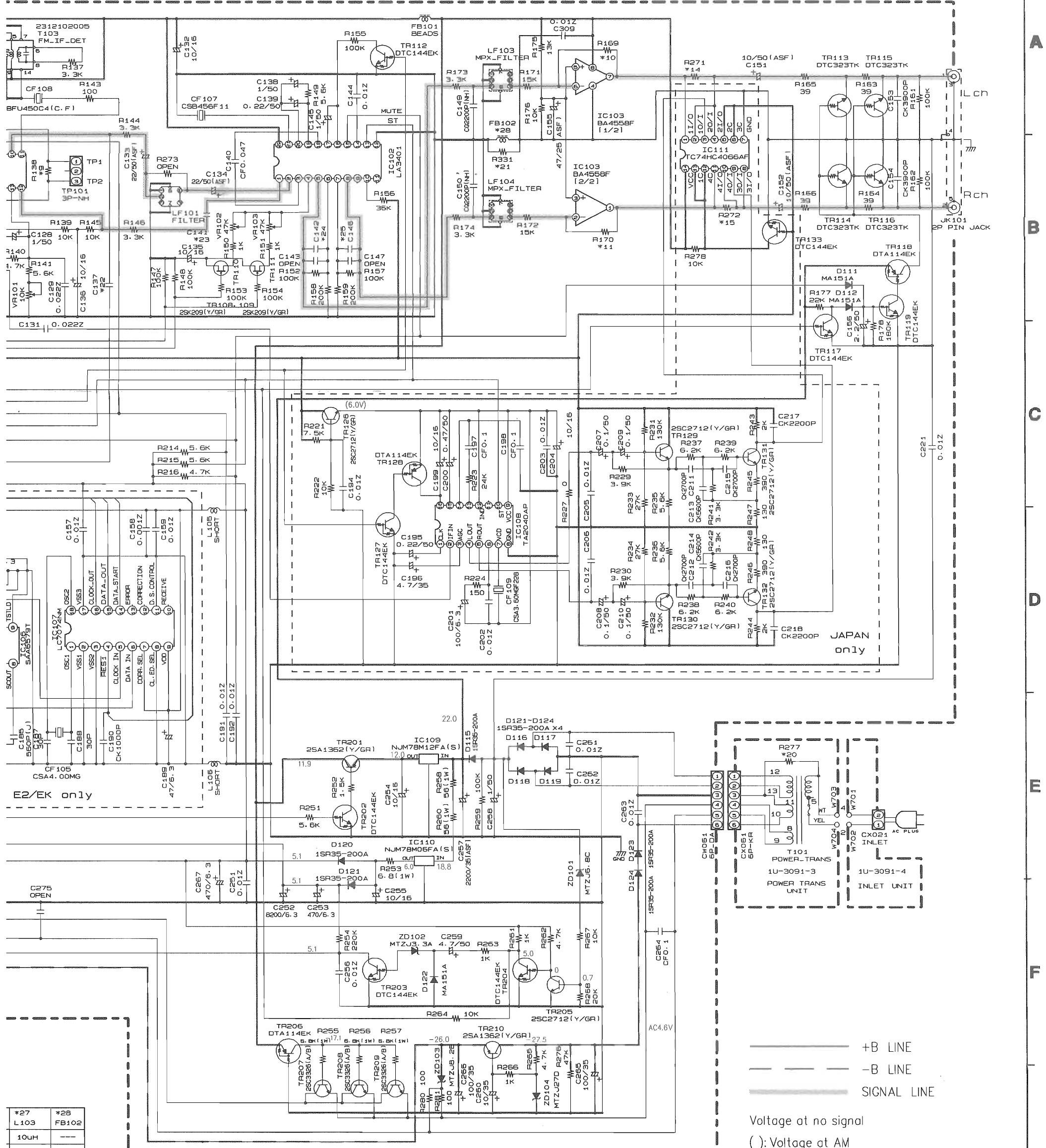

*27	*28
L103	FB102
10uH	---
JUMPER	YES
JUMPER	YES
JUMPER	---
JUMPER	---
JUMPER	---

**NOTICE**  
 ALL RESISTANCE VALUES IN OHM. k=1,000 OHM M=1,000,000 OHM  
 ALL CAPACITANCE VALUES IN MICRO FARAD. P=MICRO-MICRO FARAD  
 EACH VOLTAGE AND CURRENT ARE MEASURED AT NO SIGNAL INPUT  
 CONDITION.  
 CIRCUIT AND PARTS ARE SUBJECT TO CHANGE WITHOUT PRIOR  
 NOTICE.

**WARNING:**  
 Parts marked with this symbol have critical characteristics.  
 Use ONLY replacement parts recommended by the manufacturer.  
**CAUTION:**  
 Before returning the unit to the customer, make sure you make either (1) a  
 leakage current check or (2) a line to chassis resistance check. If the leakage  
 current exceeds 0.5 milliamperes, or if the resistance from chassis to either side  
 of the power cord is less than 240 kohms, the unit is defective.  
**WARNING:**  
 DO NOT return the unit to the customer until the problem is located and  
 corrected.

A  
B  
C  
D  
E  
F  
F  
G  
H